

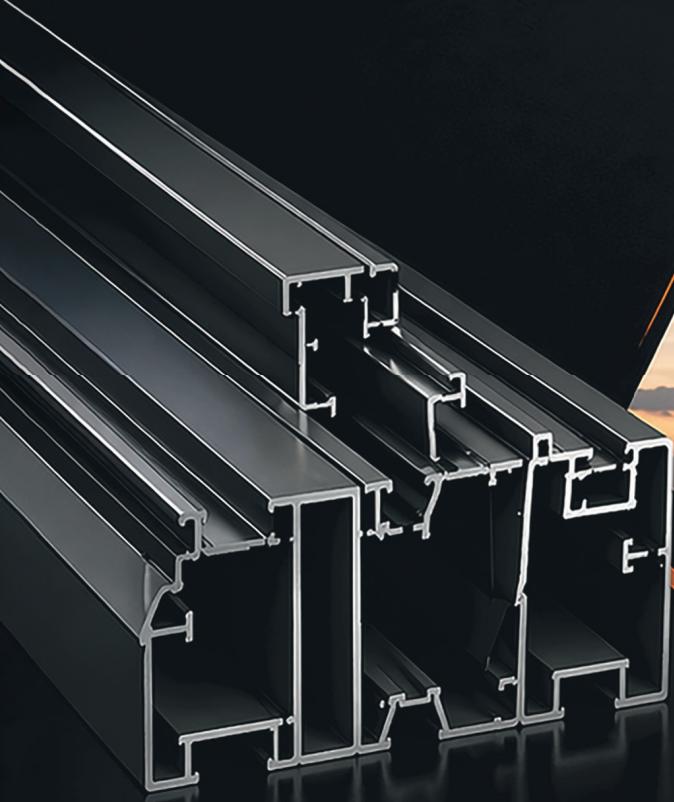

SMART

ALÜMİNYUM SİSTEMLERİ



2026

KATALOG



KALİTE
GÜVEN
ÇÖZÜM

SMART GİYOTİN / GUILLOTINE	3
SMART SÜRME SİSTEMLERİ / SMART SLIDING SYSTEMS	23
SMART BİOKLİMATİK PERGOLA / SMART BIOCLOMATIC PERGOLA	36
SMART PERGOLA / SMART PERGOLA	37
SMART CAM TAVAN / SMART GLASS CEILING	41
SMART C60 SERİSİ / SMART C60 SERIES	47
SMART ALDOKS SERİSİ / SMART ALDOX SERIES	49
SMART CEPHE PROFİLLERİ / SMART FACADE PROFILES	51
SMART SİGMA PROFİLLERİ / SMART SIGMA PROFILES	53
SMART SOLAR SİSTEM PROFİLLERİ / SMART SOLAR SYSTEM PROFILES	55
SMART STANDART PROFİL / SMART STANDARD PROFİL	58



SMART

— CAM BALKON —

ALÜMİNYUM SİSTEMLERİ

YAŞAM ALANINIZI

SINIRLAMA YOK!

GİYOTİN CAM

SİSTEMLERİ İLE

KONFORU YÜKSELTİN!

4 MEVSİM AKILLI KONFOR



MAKSİMUM IŞIK
Doğal aydınlık alanlar



YÜKSEK GÜVENLİK
Dayanıklı ve güvenli kullanım



DAYANIKLI YAPI
Güçlü alüminyum profiller



ISI YALITIMI
Enerji tasarrufu sağlar



UZAKTAN KUMANDA
Akıllı kontrol sistemi



2026

KATALOG



AYARLANABİLİR
AÇI KONTROLÜ



ENERJİ
VERİMLİLİĞİ



SESSİZ
ÇALIŞMA



UZUN ÖMÜRLÜ
KULLANIM



MODERN
TASARIM



 smartcambalkon.com



0534 292 62 22



Ovacık Mah. 2034. Sok. No:6B
Alüminyumcular Sitesi KEÇİÖREN/ANKARA

KALİTE
GÜVEN
ÇÖZÜM



SMART
— ALÜMİNYUM —

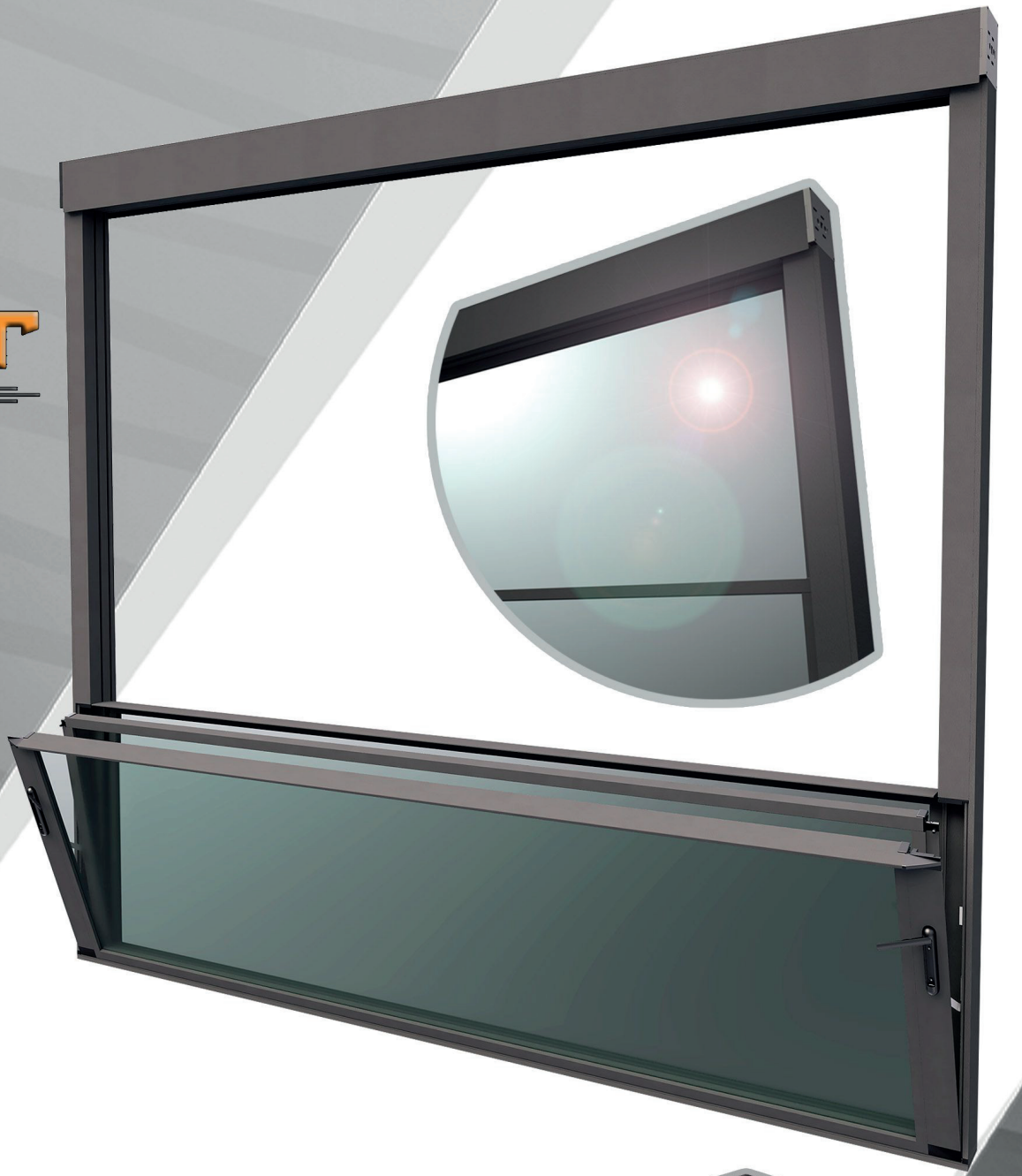

Zincirli - Kayışlı
Özel Aksesuar Setiyle



Hareketli Üst Prf.
El Sıkışmasını Önleyen
Hareketli Üst Küpeşte
profili

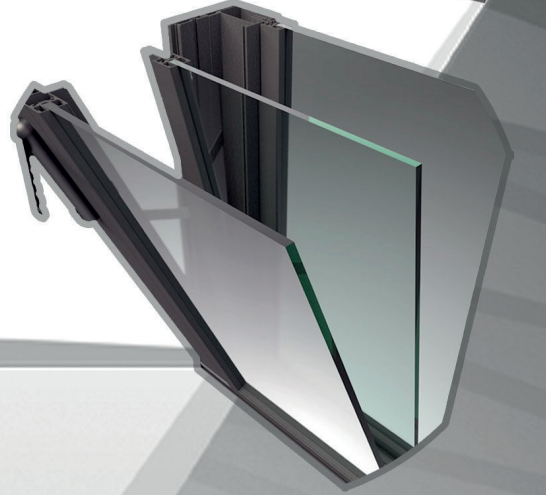

Kolay Kanat Birl.
Minimum Kalıp Sayısıyla
Firesiz Üretim

SİLİNEBİLİR GİYOTİN SİSTEM
CLEARABLE GUILLOTINE SYSTEM



SMART
ALÜMİNYUM

PROFİLLER / PROFILES

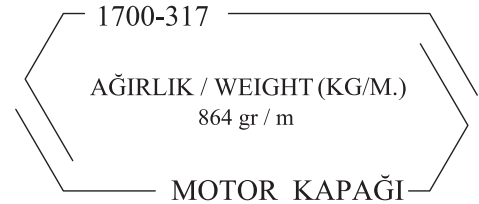
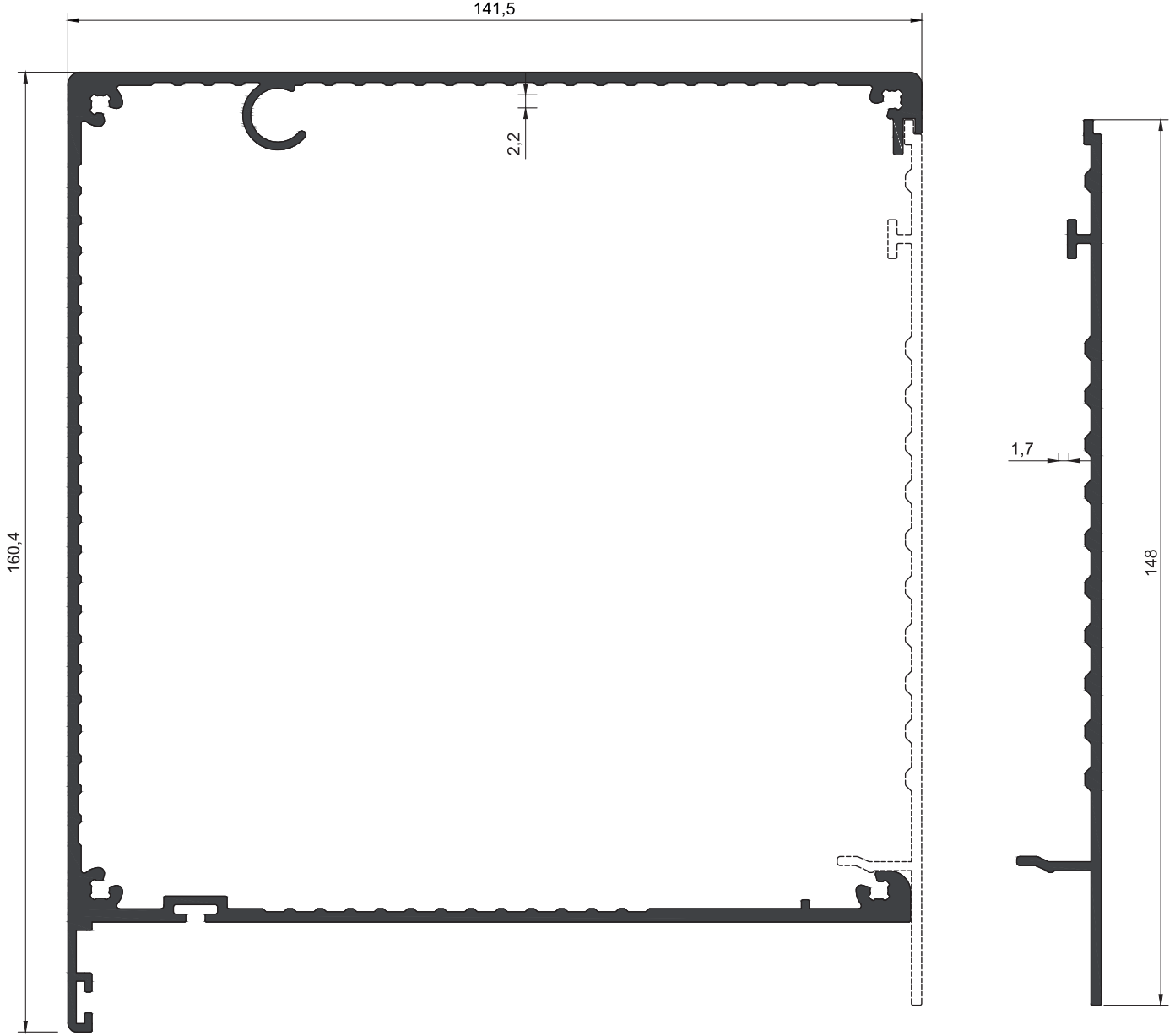

PROFİLLER / PROFILES

3

Her hakkı saklıdır. Smart Alüminyum izni olmadan kopya edilemez, çoğaltılamaz ve yayımlanamaz.
Copyright © All rights reserved. It shall not be reproduced without permission of Smart Alüminyum

Katalogdaki profil ağırlıkları teoriktir. Teslimat öncesi ölçülen değerler geçerlidir.
Profile weights at the catalogue are theoretical, pre-shipment values will be valid.



smart.cam.balkon



+90 534 292 6222

SİLİNEBİLİR GİYOTİN SİSTEM CLEARABLE GUILLOTINE SYSTEM



PROFİLLER / PROFILES

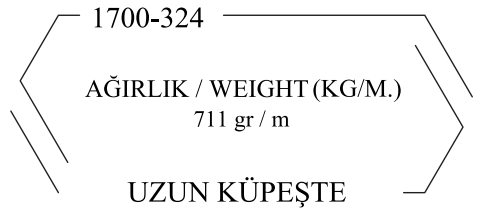
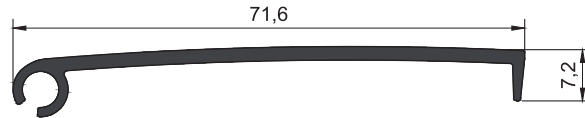
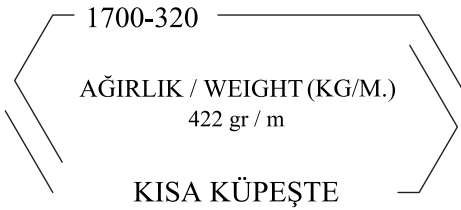
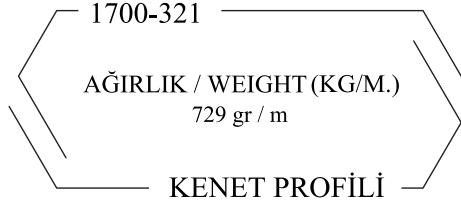
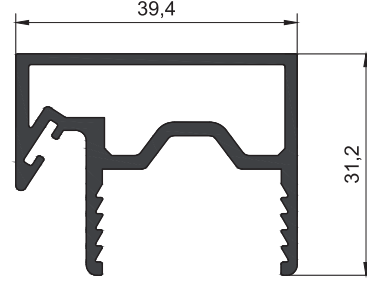
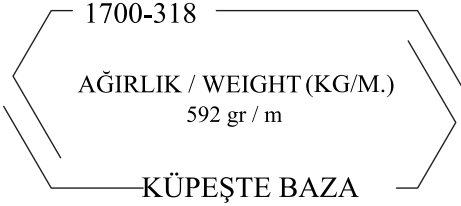
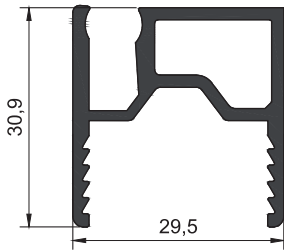
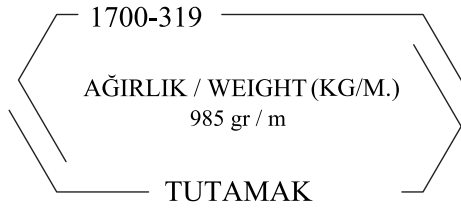
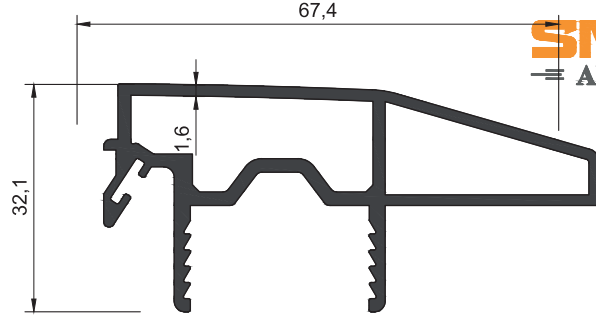
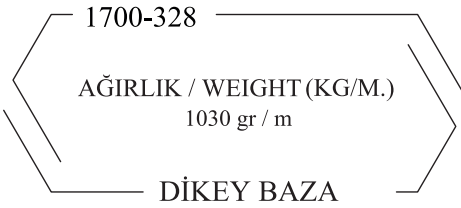
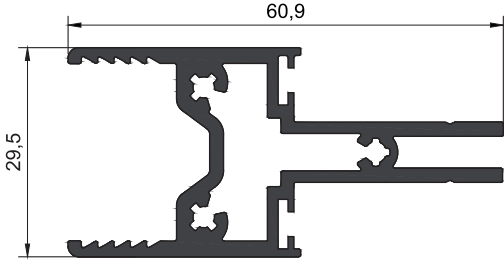

PROFİLLER / PROFILES

4

Her hakkı saklıdır. Smart Alüminyum izni olmadan kopya edilemez, çoğaltılamaz ve yayımlanamaz.
Copyright © All rights reserved. It shall not be reproduced without permission of Smart Alüminyum
Katalogdaki profil ağırlıkları teoriktir. Teslimat öncesi ölçülen değerler geçerlidir.
Profile weights at the catalogue are theoretical, pre-shipment values will be valid.



smart.cam.balkon



+90 534 292 6222

SİLİNEBİLİR GİYOTİN SİSTEM
CLEARABLE GUILLOTINE SYSTEM



SMART
ALÜMİNYUM

PROFİLLER / PROFILES

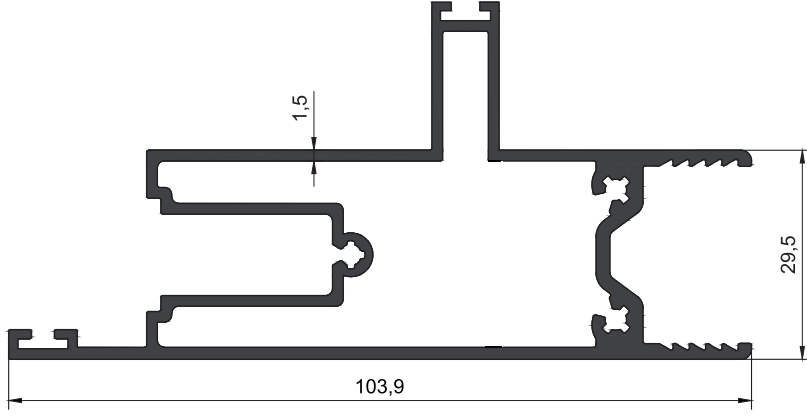

1700-322

AĞIRLIK / WEIGHT (KG/M.)
1522 gr / m

KANAT PROFİLİ

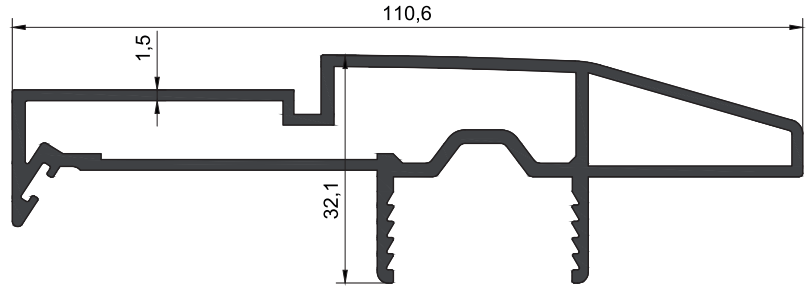

1700-329

AĞIRLIK / WEIGHT (KG/M.)
1378 gr / m

2 CAMLI GİYOTİN ADP.

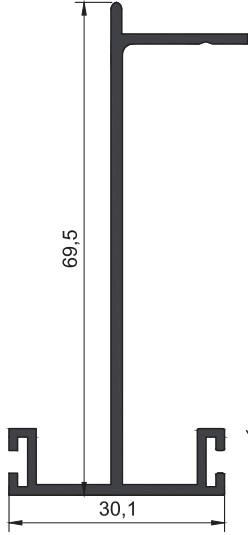

1700-315

AĞIRLIK / WEIGHT (KG/M.)
581 gr / m

ARA DİKME PRF.

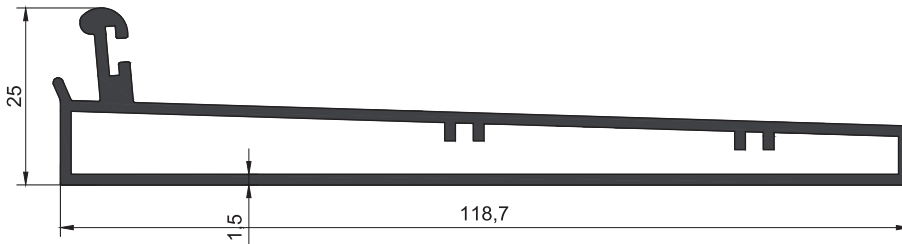

1700-325

AĞIRLIK / WEIGHT (KG/M.)
1209 gr / m

ALT KASA PROFİLİ

PROFİLLER / PROFILES

5

Her hakkı saklıdır. Smart Alüminyum izni olmadan kopya edilemez, çoğaltılamaz ve yayımlanamaz.
Copyright © All rights reserved. It shall not be reproduced without permission of Smart Alüminyum

Katalogdaki profil ağırlıkları teoriktir. Teslimat öncesi ölçülen değerler geçerlidir.
Profile weights at the catalogue are theoretical, pre-shipment values will be valid.



smart.cam.balkon



+90 534 292 6222

SİLİNEBİLİR GİYOTİN SİSTEM
CLEARABLE GUILLOTINE SYSTEM



SMART
ALÜMİNYUM

PROFİLLER / PROFILES

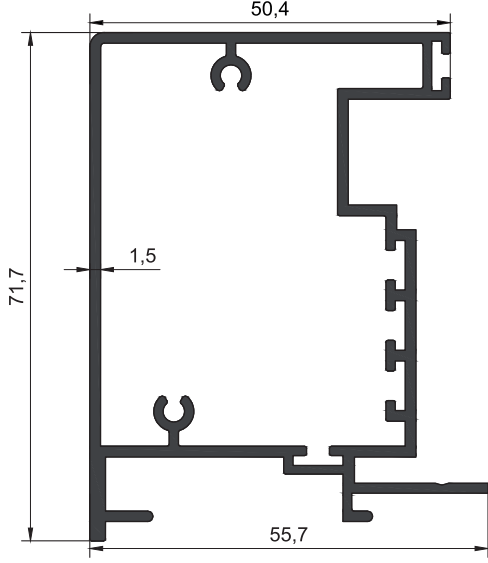

1700-327
AĞIRLIK / WEIGHT (KG/M.)
1223 gr / m
SON KAPATMA PRF.

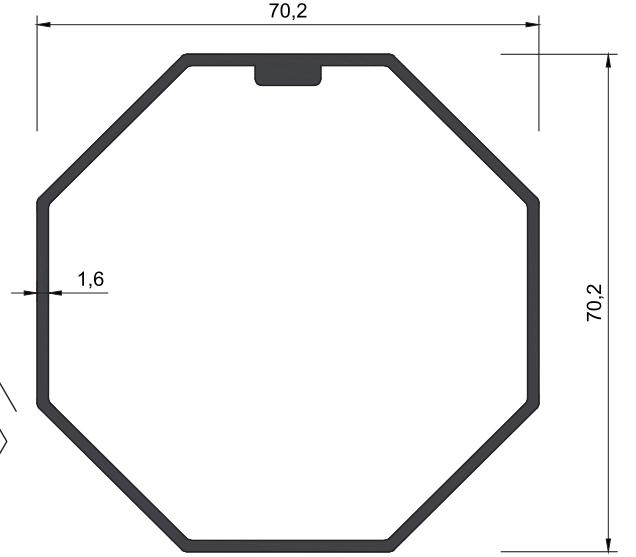

1856
AĞIRLIK / WEIGHT (KG/M.)
938 gr / m
SEKİZGEN BORU

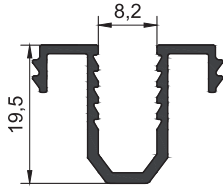

1700-326
AĞIRLIK / WEIGHT (KG/M.)
190 gr / m
8MM ÇITA

1700-323
AĞIRLIK / WEIGHT (KG/M.)
1696 gr / m
YAN KASA PROFİLİ

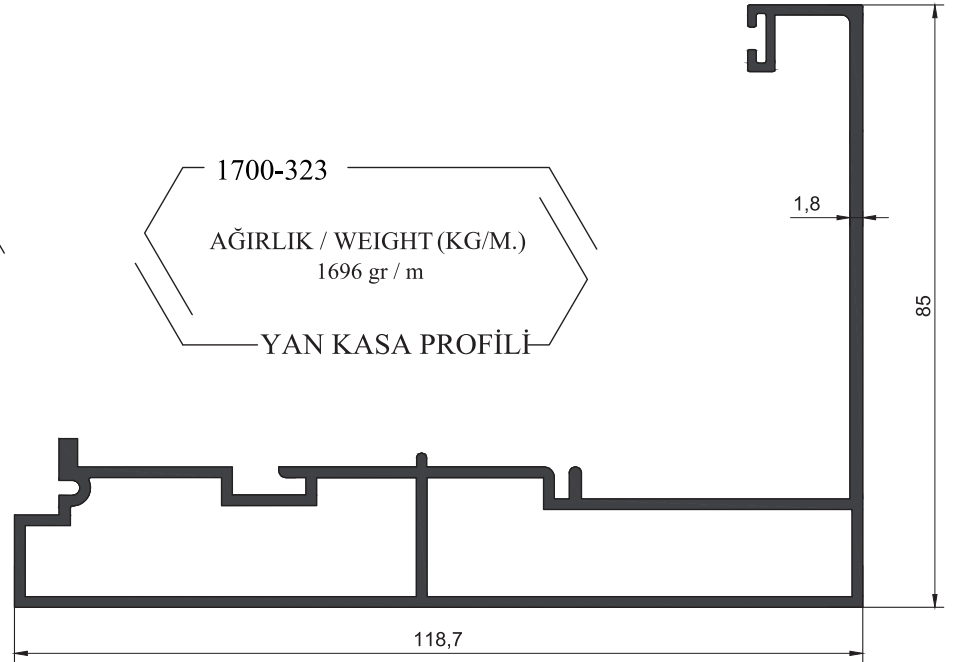

PROFİLLER / PROFILES

6

Her hakkı saklıdır. Smart Alüminyum izni olmadan kopya edilemez, çoğaltılamaz ve yayımlanamaz.
Copyright © All rights reserved. It shall not be reproduced without permission of Smart Alüminyum
Katalogdaki profil ağırlıkları teoriktir. Teslimat öncesi ölçülen değerler geçerlidir.
Profile weights at the catalogue are theoretical, pre-shipment values will be valid.



smart.cam.balkon



+90 534 292 6222

SİLİNEBİLİR GİYOTİN SİSTEM CLEARABLE GUILLOTINE SYSTEM



kod	şekil	tanım	paket metraji	kullanım yeri
GY-01		Alt Kasa Köşe Takoğu (POLYAMID)	1L+1R	
GY-02		Motor Kapağı Sol (POLYAMID)	1L	
GY-03		Motor Kapağı Sağ (POLYAMID)	1R	
GY-04		Motor Kızağı Kare	1	
GY-05		Boru Başı Zamak	1	
GY-06		Denge Takoğu	8	
GY-07		Vida Kapağı Fitolu	4L+4R	
GY-08		Son Kapatma Takoz	1L+1R	
GY-09		Kanat Alt Takoğu	1L+1R	

AKSESUAR / ACCESSORY

8

Her hakkı saklıdır. Smart Alüminyum izni olmadan kopya edilemez, çoğaltılamaz ve yayımlanamaz.
Copyright © All rights reserved. It shall not be reproduced without permission of Smart Alüminyum
Katalogdaki profil ağırlıkları teoriktir. Teslimat öncesi ölçülen değerler geçerlidir.
Profile weights at the catalogue are theoretical, pre-shipment values will be valid.



smart.cam.balkon



+90 534 292 6222

SİLİNEBİLİR GİYOTİN SİSTEM CLEARABLE GUILLOTINE SYSTEM



kod	şekil	tanım	paket metraji	kullanım yeri
GY-10		Kanat Alt Takoza	1L+1R	
GY-11		Push Kol	2	
GY-12		Vasistas Makas	2	
GY-13		İspanyolet kilit	2	
GY-14		Zincir Dişlisi	2	
GY-15		Zincir Yönlendirici	2	
GY-16		Zincir 2,5 m	2	
GY-17		Zincir ve Kayış Tutucu	2	

AKSESUAR / ACCESSORY

9

Her hakkı saklıdır. Smart Alüminyum izni olmadan kopya edilemez, çoğaltılamaz ve yayımlanamaz.
Copyright © All rights reserved. It shall not be reproduced without permission of Smart Alüminyum

Katalogdaki profil ağırlıkları teoriktir. Teslimat öncesi ölçülen değerler geçerlidir.
Profile weights at the catalogue are theoretical, pre-shipment values will be valid.



smart.cam.balkon



+90 534 292 6222

SİLİNEBİLİR GİYOTİN SİSTEM CLEARABLE GUILLOTINE SYSTEM



kod	şekil	tanım	paket metraji	kullanım yeri
GY-18		Kayış Kasnağı	2	
GY-19		Kayış 2,5 m	2	
GY-20		Motor Borusu	1	
GY21		Epdm Kapak Baskı Fitiği	65 gr/m 153 m	
GY-22		Kıl Fitiği 67 x 600 67 x 1200	400 m/pk	
GY-23		Epdm Kanat Baskı Fitiği	40gr/m 200 m	
GY-24		Merkezleme Takoğu	2	
GY-26		Motor Kızağı Rulmanlı	1	

AKSESUAR / ACCESSORY

10

Her hakkı saklıdır. Smart Alüminyum izni olmadan kopya edilemez, çoğaltılamaz ve yayımlanamaz.
Copyright © All rights reserved. It shall not be reproduced without permission of Smart Alüminyum
Katalogdaki profil ağırlıkları teoriktir. Teslimat öncesi ölçülen değerler geçerlidir.
Profile weights at the catalogue are theoretical, pre-shipment values will be valid.



smart.cam.balkon



+90 534 292 6222

SİLİNEBİLİR GİYOTİN SİSTEM CLEARABLE GUILLOTINE SYSTEM



SMART
= ALÜMİNYUM =

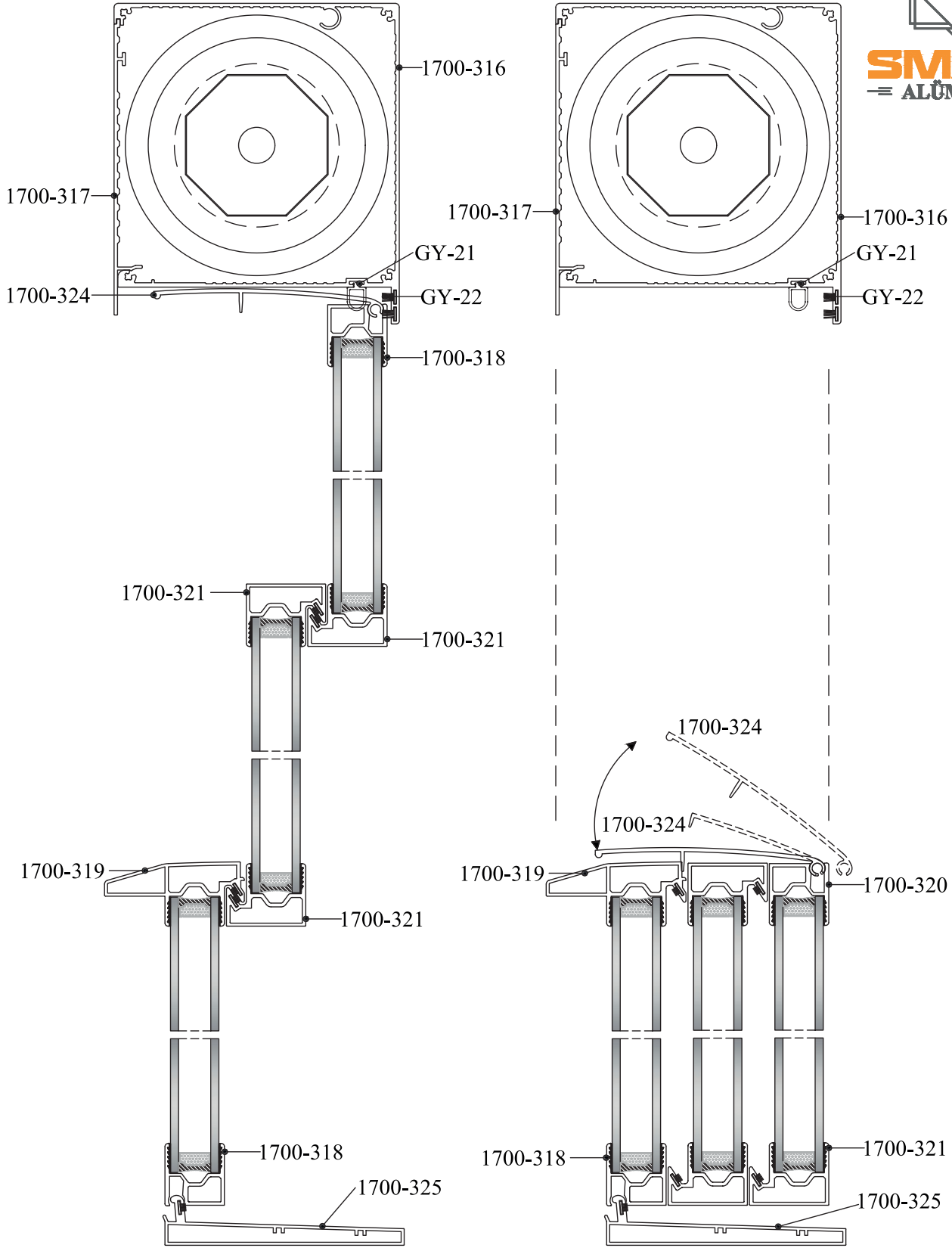

C-C KESİTİ

D-D KESİTİ

GIYOTİN SİSTEM KAPALI KESİT (DİKEY)

GIYOTİN SİSTEM AÇIK KESİT (DİKEY)

DETAYLAR / DETAILS

11

Her hakkı saklıdır. Smart Alüminyum izni olmadan kopya edilemez, çoğaltılamaz ve yayımlanamaz.
Copyright © All rights reserved. It shall not be reproduced without permission of Smart Alüminyum

Katalogdaki profil ağırlıkları teoriktir. Teslimat öncesi ölçülen değerler geçerlidir.
Profile weights at the catalogue are theoretical, pre-shipment values will be valid.



smart.cam.balkon



+90 534 292 6222

SİLİNEBİLİR GİYOTİN SİSTEM CLEARABLE GUILLOTINE SYSTEM



SMART
ALÜMİNYUM

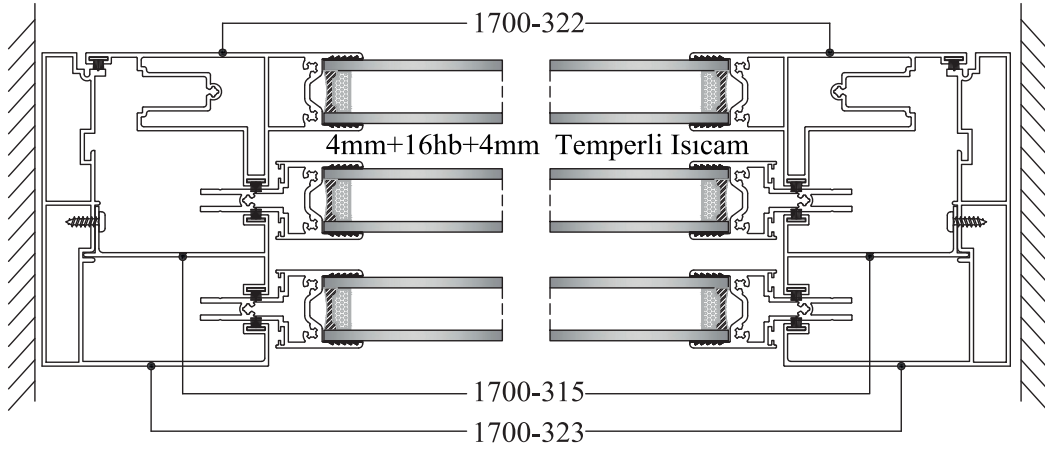
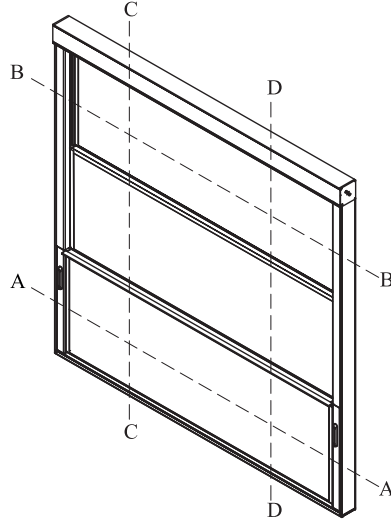

A-A KESİTİ

GİYOTİN SİSTEM AÇIK KESİT (YATAY)

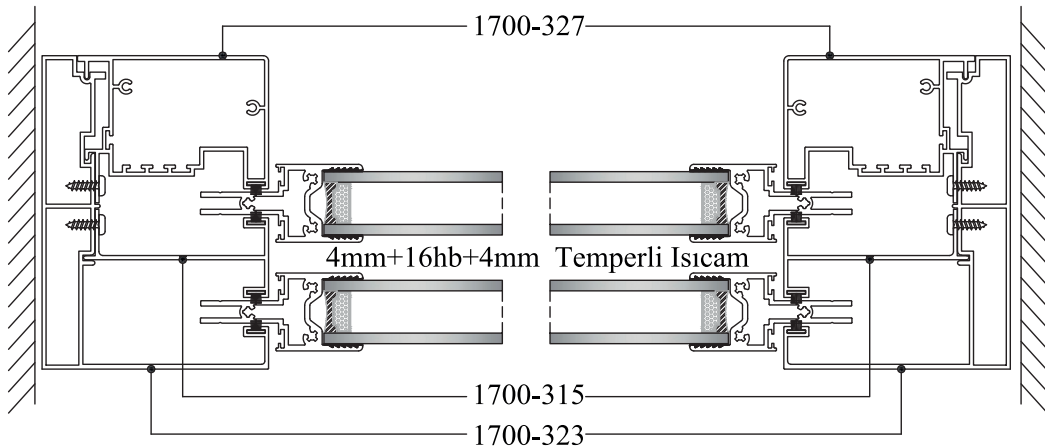

B-B KESİTİ

GİYOTİN SİSTEM KAPALI KESİT (YATAY)

DETAYLAR / DETAILS

12

Her hakkı saklıdır. Smart Alüminyum izni olmadan kopya edilemez, çoğaltılamaz ve yayımlanamaz.
Copyright © All rights reserved. It shall not be reproduced without permission of Smart Alüminyum

Katalogdaki profil ağırlıkları teoriktir. Teslimat öncesi ölçülen değerler geçerlidir.
Profile weights at the catalogue are theoretical, pre-shipment values will be valid.



smart.cam.balkon



+90 534 292 6222

SİLİNEBİLİR GİYOTİN SİSTEM CLEARABLE GUILLOTINE SYSTEM



SMART
ALÜMİNYUM

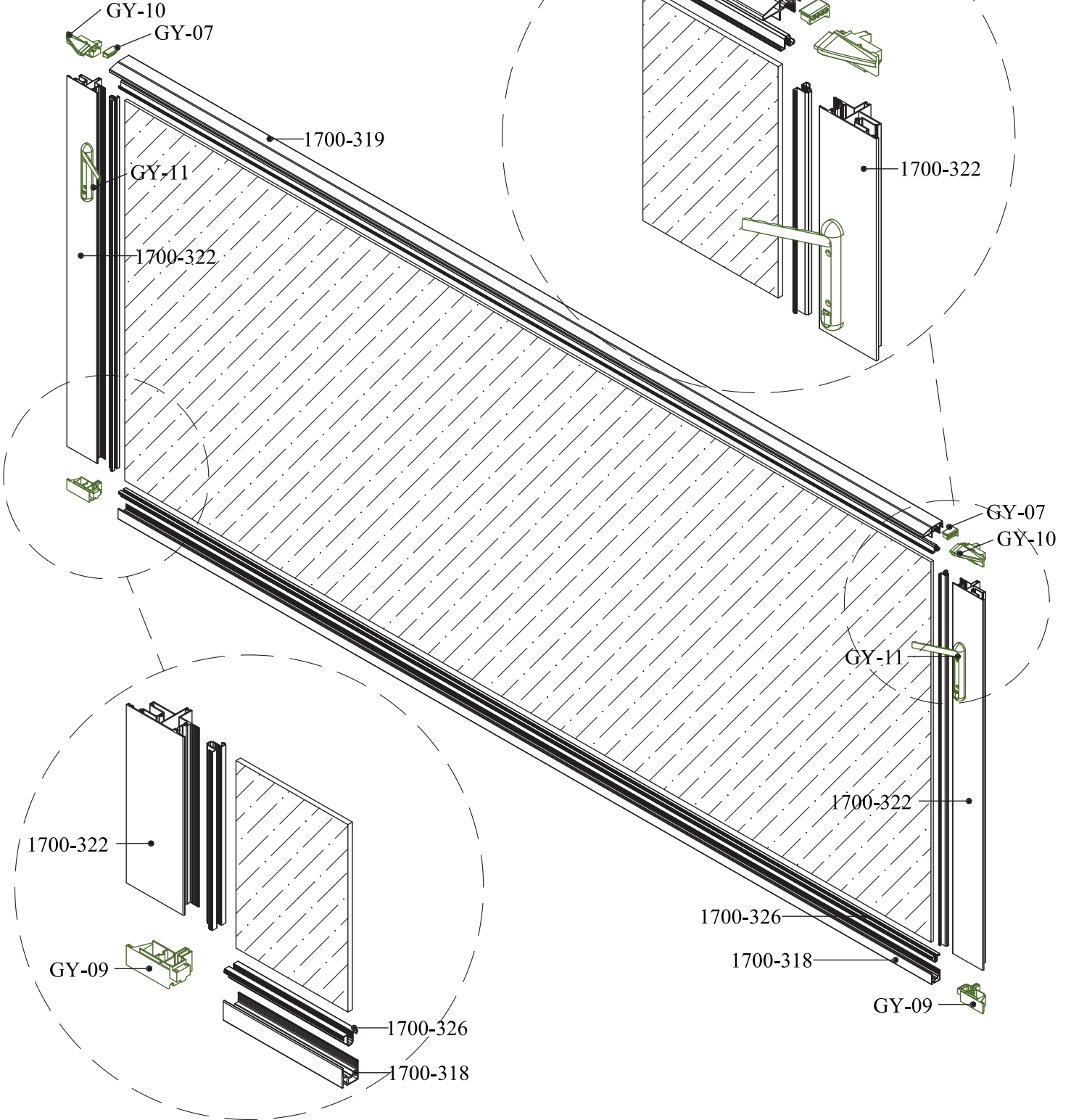

DETAYLAR / DETAILS

13

Her hakkı saklıdır. Smart Alüminyum izni olmadan kopya edilemez, çoğaltılamaz ve yayımlanamaz.
Copyright © All rights reserved. It shall not be reproduced without permission of Smart Alüminyum
Katalogdaki profil ağırlıkları teoriktir. Teslimat öncesi ölçülen değerler geçerlidir.
Profile weights at the catalogue are theoretical, pre-shipment values will be valid.



smart.cam.balkon



+90 534 292 6222

SİLİNEBİLİR GİYOTİN SİSTEM CLEARABLE GUILLOTINE SYSTEM



SMART
= ALÜMİNYUM =

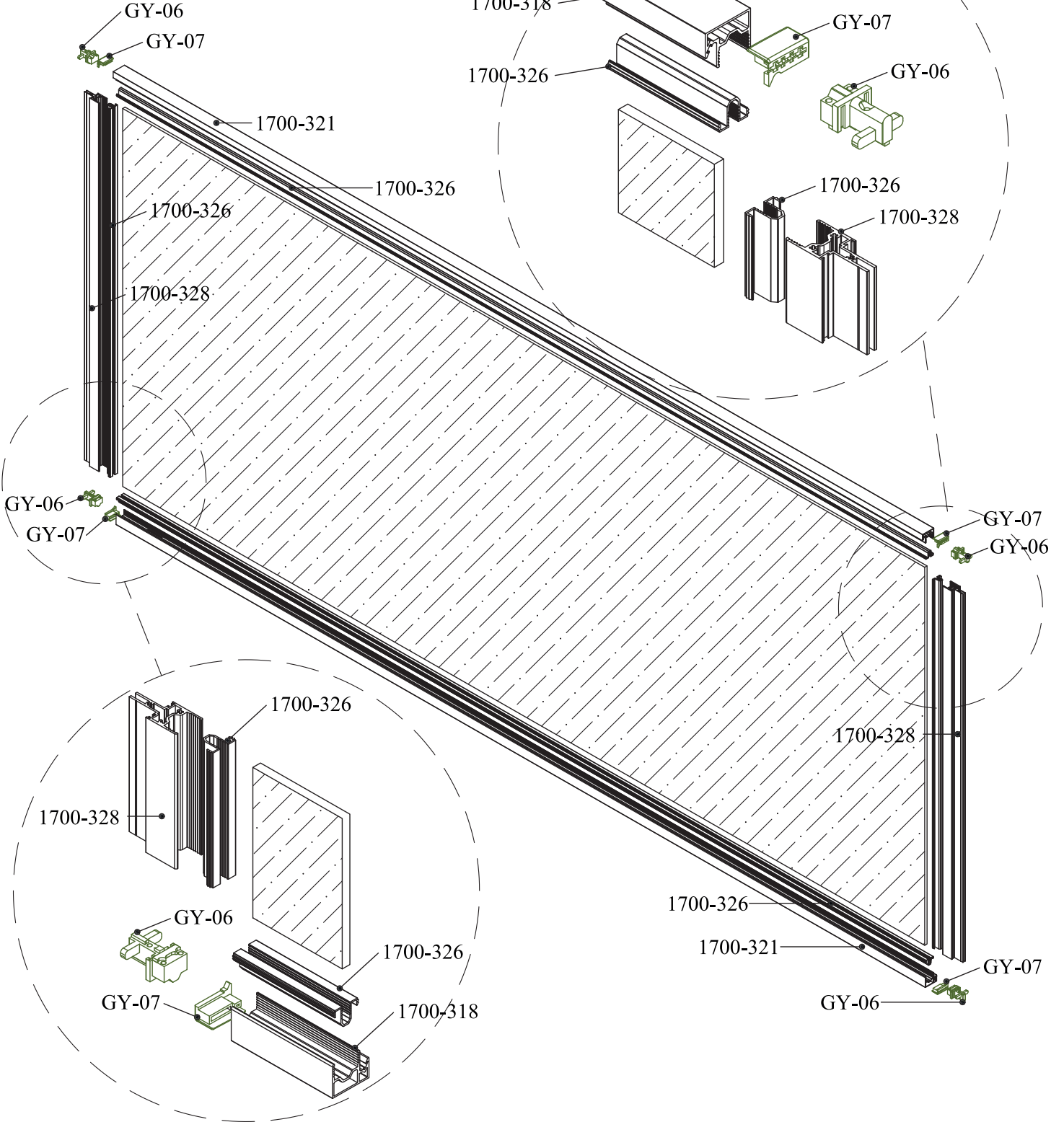

DETAYLAR / DETAILS

14

Her hakkı saklıdır. Smart Alüminyum izni olmadan kopya edilemez, çoğaltılamaz ve yayımlanamaz.
Copyright © All rights reserved. It shall not be reproduced without permission of Smart Alüminyum
Katalogdaki profil ağırlıkları teoriktir. Teslimat öncesi ölçülen değerler geçerlidir.
Profile weights at the catalogue are theoretical, pre-shipment values will be valid.



smart.cam.balkon



+90 534 292 6222

SİLİNEBİLİR GİYOTİN SİSTEMİ CLEARABLE GUILLOTINE SYSTEM



SMART
ALÜMİNYUM

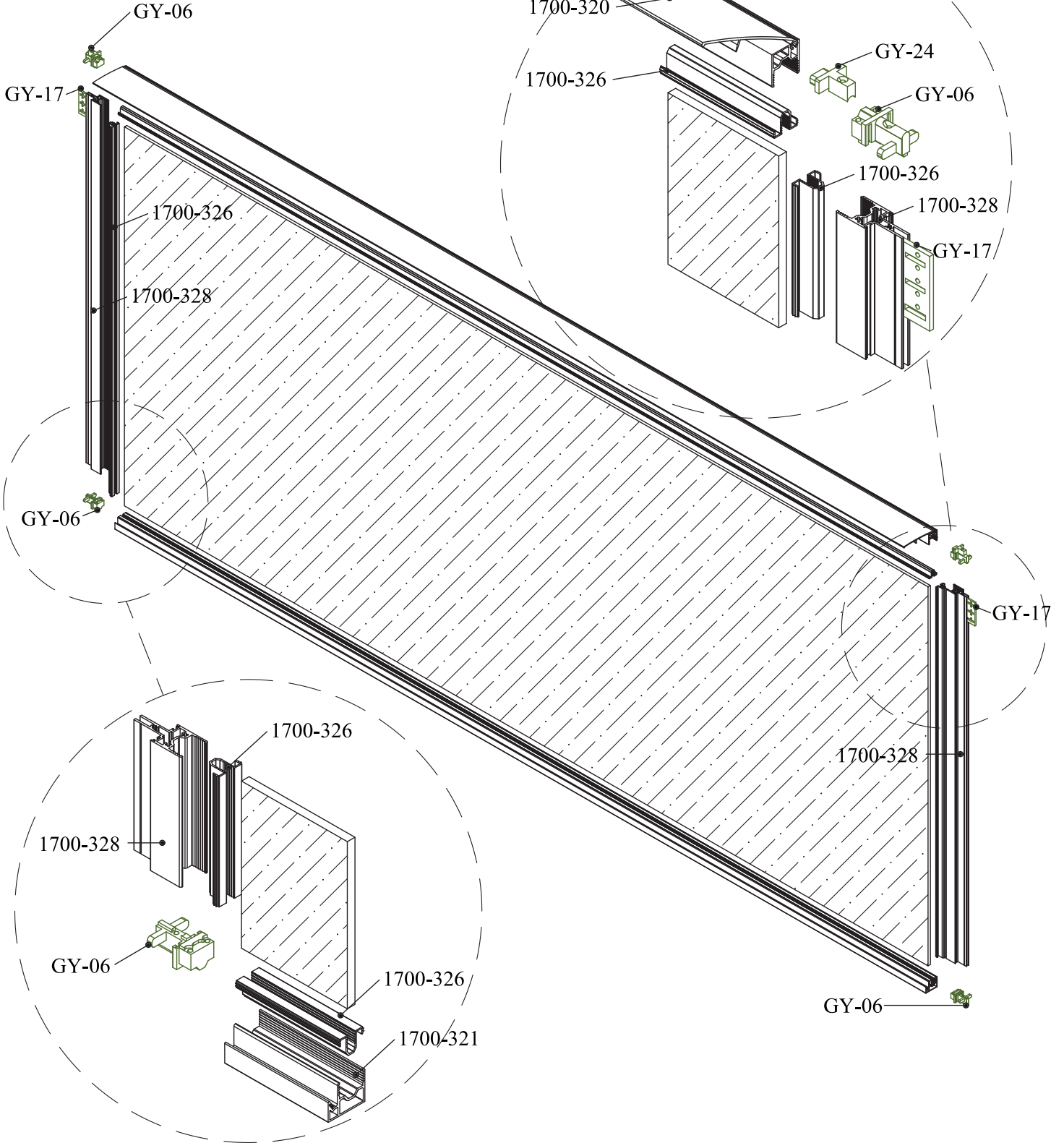

DETAYLAR / DETAILS

15

Her hakkı saklıdır. Smart Alüminyum izni olmadan kopya edilemez, çoğaltılamaz ve yayımlanamaz.
Copyright © All rights reserved. It shall not be reproduced without permission of Smart Alüminyum
Katalogdaki profil ağırlıkları teoriktir. Teslimat öncesi ölçülen değerler geçerlidir.
Profile weights at the catalogue are theoretical, pre-shipment values will be valid.



smart.cam.balkon



+90 534 292 6222

SİLİNEBİLİR GİYOTİN SİSTEMİ CLEARABLE GUILLOTINE SYSTEM



SMART
ALÜMİNYUM

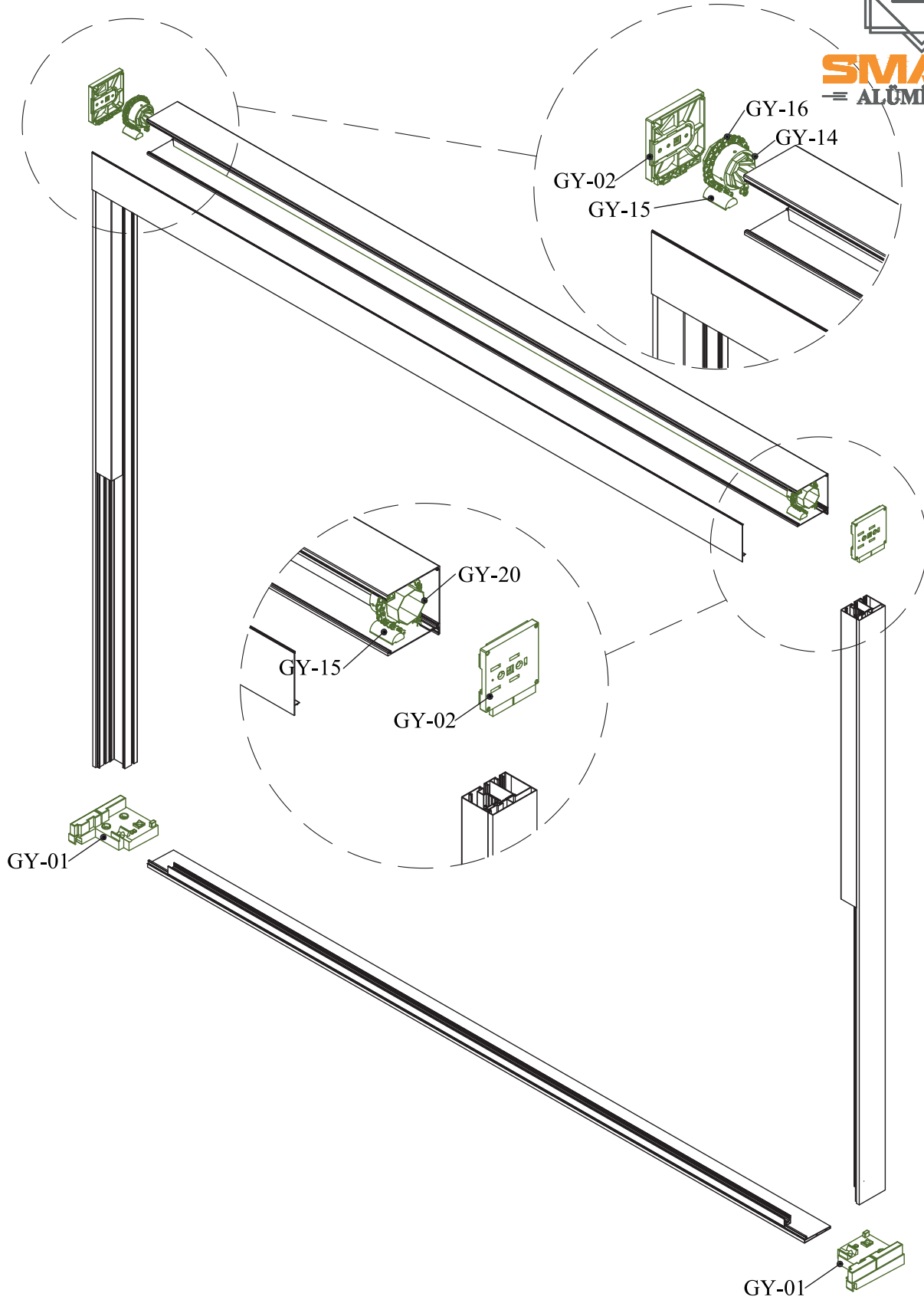

DETAYLAR / DETAILS

16

Her hakkı saklıdır. Smart Alüminyum izni olmadan kopya edilemez, çoğaltılamaz ve yayımlanamaz.
Copyright © All rights reserved. It shall not be reproduced without permission of Smart Alüminyum
Katalogdaki profil ağırlıkları teoriktir. Teslimat öncesi ölçülen değerler geçerlidir.
Profile weights at the catalogue are theoretical, pre-shipment values will be valid.



smart.cam.balkon



+90 534 292 6222

SİLİNEBİLİR GİYOTİN SİSTEM
CLEARABLE GUILLOTINE SYSTEM



SMART
ALÜMİNYUM

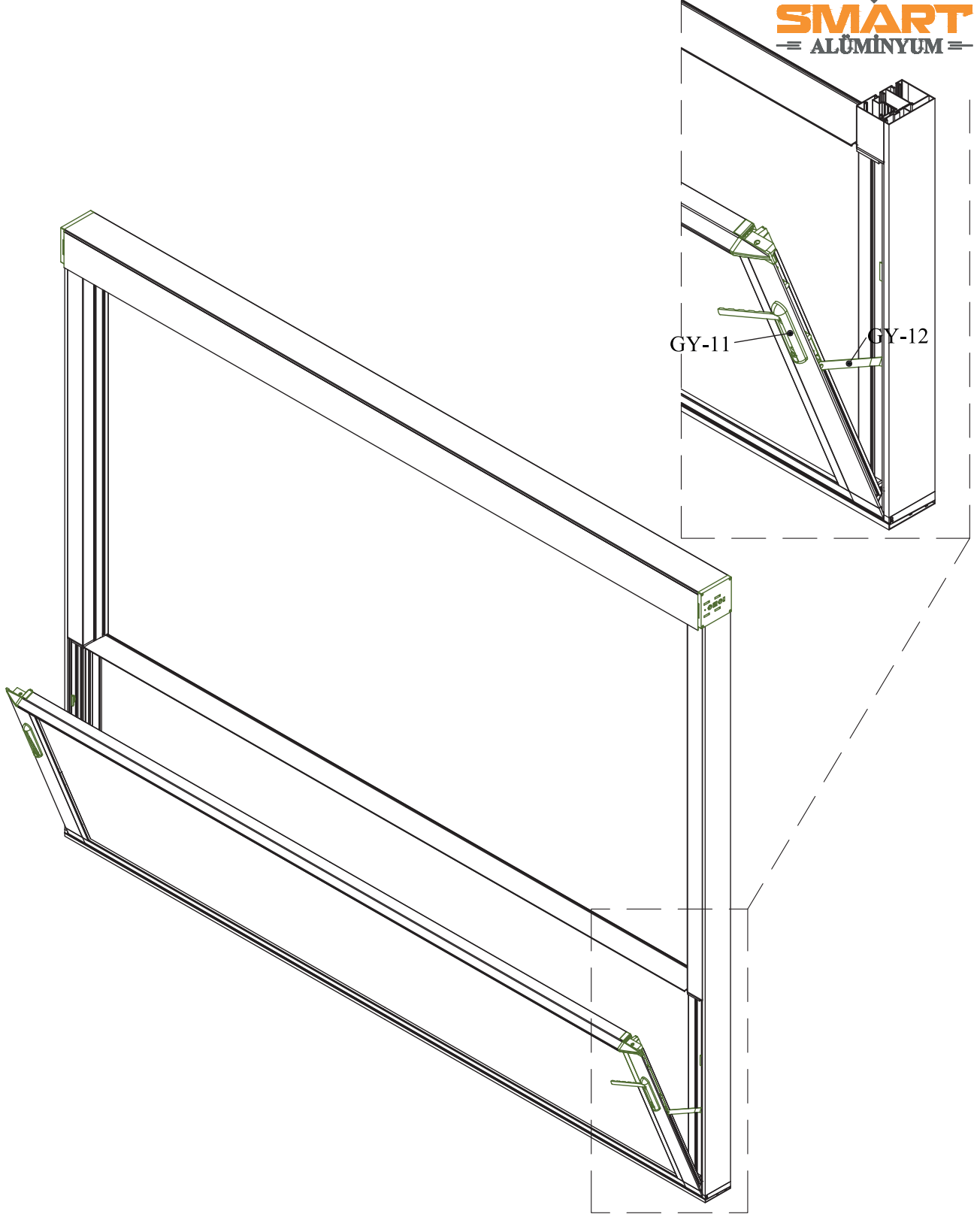

DETAYLAR / DETAILS

17

Her hakkı saklıdır. Smart Alüminyum izni olmadan kopya edilemez, çoğaltılamaz ve yayımlanamaz.
Copyright © All rights reserved. It shall not be reproduced without permission of Smart Alüminyum

Katalogdaki profil ağırlıkları teoriktir. Teslimat öncesi ölçülen değerler geçerlidir.
Profile weights at the catalogue are theoretical, pre-shipment values will be valid.



smart.cam.balkon



+90 534 292 6222

SİLİNEBİLİR GİYOTİN SİSTEM
CLEARABLE GUILLOTINE SYSTEM



SMART
ALÜMİNYUM

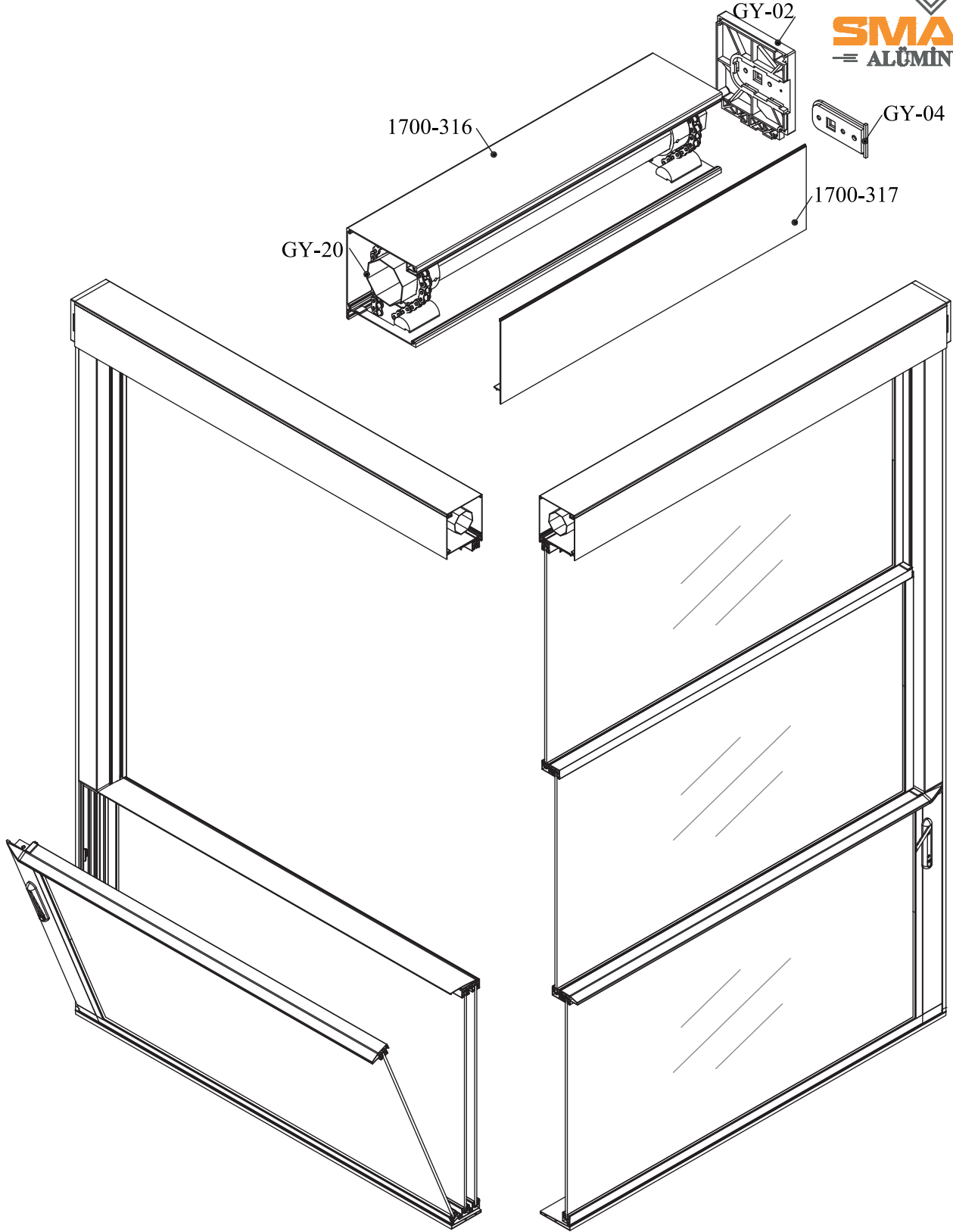

PERSPEKTİF

18

Her hakkı saklıdır. Smart Alüminyum izni olmadan kopya edilemez, çoğaltılamaz ve yayımlanamaz.
Copyright © All rights reserved. It shall not be reproduced without permission of Smart Alüminyum

Katalogdaki profil ağırlıkları teoriktir. Teslimat öncesi ölçülen değerler geçerlidir.
Profile weights at the catalogue are theoretical, pre-shipment values will be valid.



smart.cam.balkon



+90 534 292 6222

SİLİNEBİLİR GİYOTİN SİSTEMİ CLEARABLE GUILLOTINE SYSTEM



SMART
= ALÜMİNYUM =

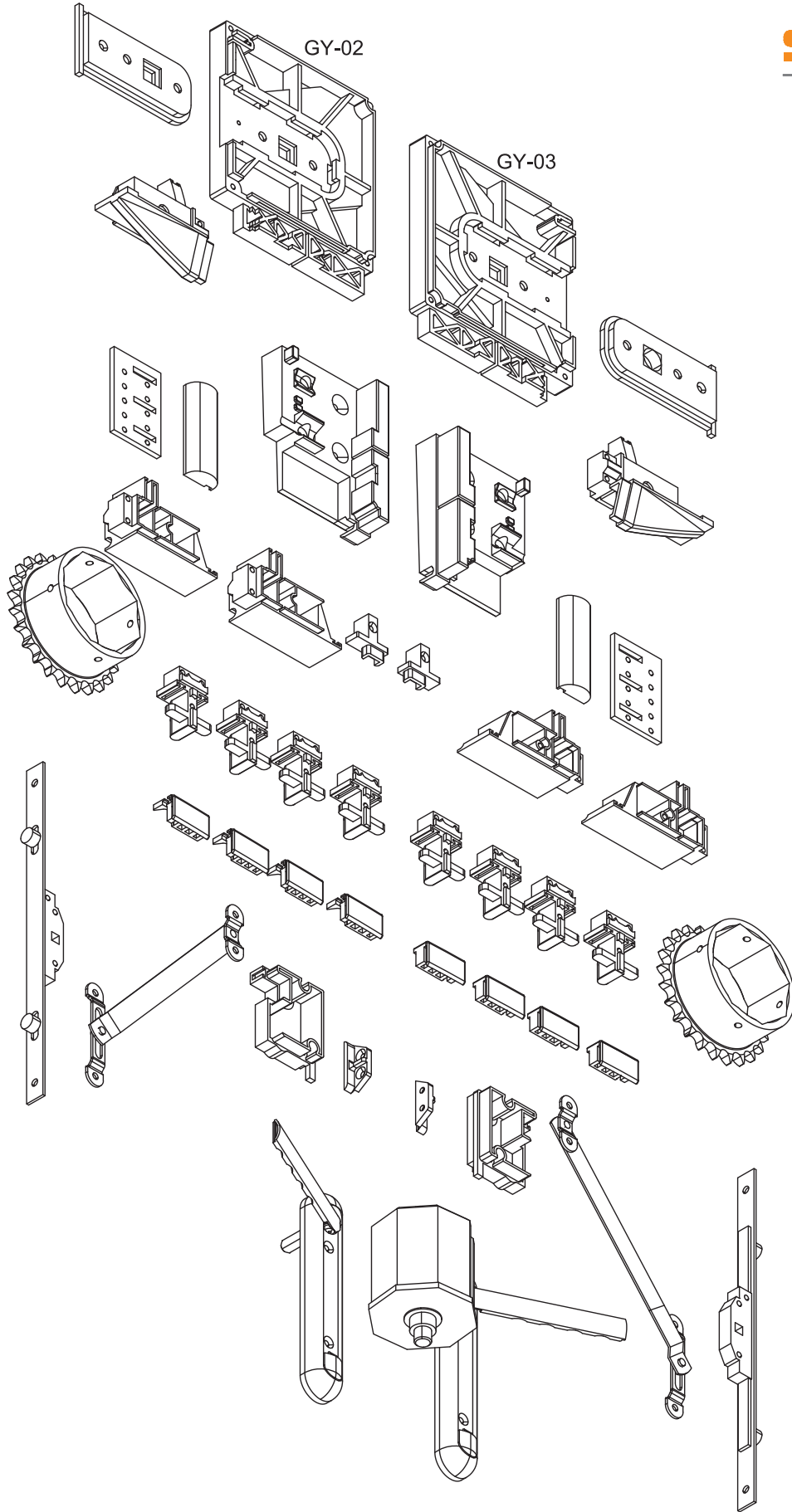



SMART
— ALÜMİNYUM —





SMART

— CAM BALKON —
ALÜMİNYUM SİSTEMLERİ

YAŞAM ALANINIZI
SINIRLAMA YOK!

SÜRGÜLÜ SÜRME
CAM BALKON SİSTEMLERİ
İLE KONFORU YÜKSELTİN!

4 MEVSİM AKILLI KONFOR



RAHAT KULLANIM
Sürgülü sistem ile kolay açılım



MAKSİMUM AÇILIM
Paneller tamamen toplanır
açık alan keyfi



YÜKSEK GÜVENLİK
Temperli cam ve kilit sistemi



SU VE RÜZGAR YALITIMI
Özel fitil yapısı ile
maksimum yalıtım



BAHÇE VE KAPI UYGULAMASI



TİCARİ ALAN UYGULAMASI



BALKON UYGULAMASI



AYARLANABİLİR
AÇI KONTROLÜ



ENERJİ
VERİMLİLİĞİ



SESSİZ
ÇALIŞMA



UZUN ÖMÜRLÜ
KULLANIM



MODERN
TASARIM



smarcambalkon.com



0534 292 62 22



Ovaçık Mah. 2034. Sok. No:6B
Alüminyumcular Sitesi KEÇİÖREN/ANKARA

KALİTE
GÜVEN
ÇÖZÜM



SMART
— ALÜMİNYUM —

PRO SÜRME SİSTEMİ



**Optimize Edilmiş
Profil Kesitleri**
Firesiz Üretim

**Modüler Arttırılabilir
Ray Sistemi**
Eklemeli ray sistemi

Kolay Kanat Birl.
Minimum Kalıp Sayısıyla
Firesiz Üretim



PROFİLLER / PROFILES

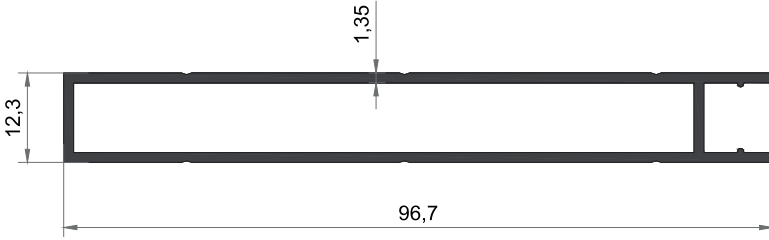

1700-311

AĞIRLIK / WEIGHT (KG/M.)
790 gr / m

YAN KASA PRF.

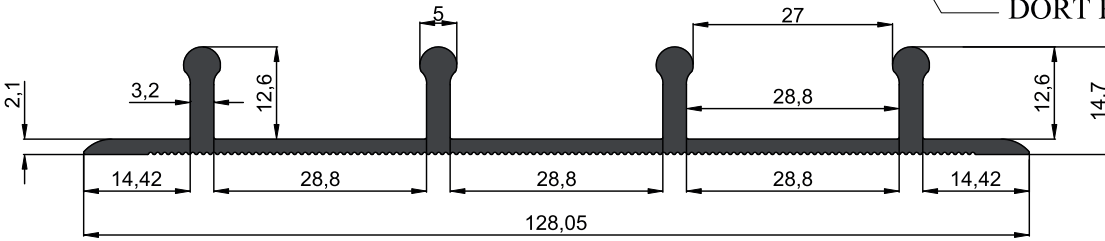

1700-303

AĞIRLIK / WEIGHT (KG/M.)
1551 gr / m

DÖRT RAYLI EŞİKSİZ PRF.

M (2 : 1)

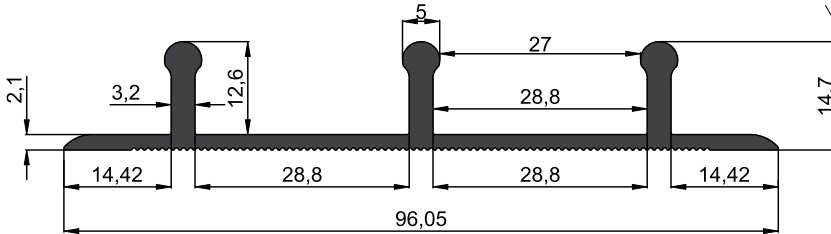

1700-304

AĞIRLIK / WEIGHT (KG/M.)
863 gr / m

ÜÇ RAYLI EŞİKSİZ PRF.

M (2 : 1)



SÜRME SİSTEM

ECO SLİM SÜRME SİSTEM PROFİLLERİ



SMART
ALÜMİNYUM

PROFİLLER / PROFILES

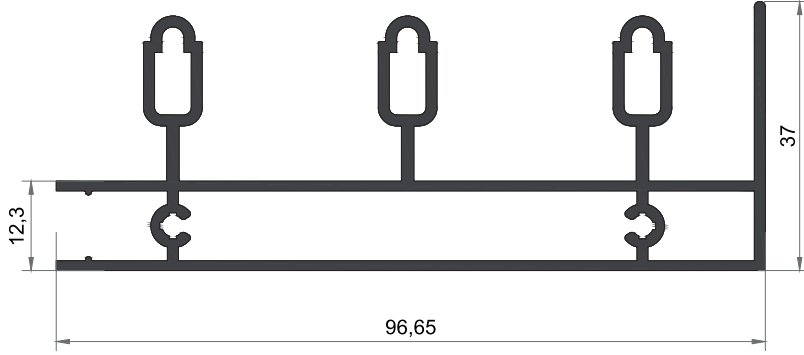

1700-310

AĞIRLIK / WEIGHT (KG/M.)
1525 gr / m

ALT - ÜST RAY PRF.

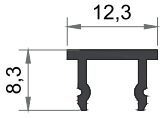

1700-312

AĞIRLIK / WEIGHT (KG/M.)
85 gr / m

RAY ve DİKME KAPAK

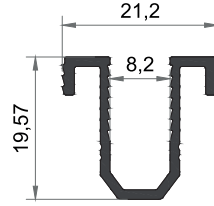

1700-305

AĞIRLIK / WEIGHT (KG/M.)
215 gr / m

8MM ÇITA

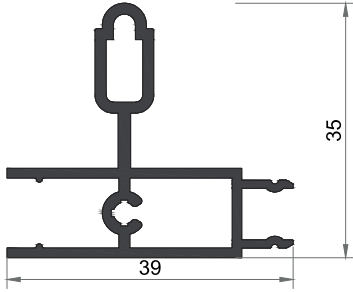

1700-308

AĞIRLIK / WEIGHT (KG/M.)
570 gr / m

EK RAY PRF.

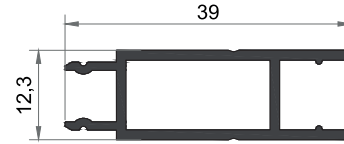

1700-313

AĞIRLIK / WEIGHT (KG/M.)
355 gr / m

EK DİKME PRF.

PROFİLLER / PROFILES

24

Her hakkı saklıdır. Smart Alüminyum izni olmadan kopya edilemez, çoğaltılamaz ve yayımlanamaz.
Copyright © All rights reserved. It shall not be reproduced without permission of Smart Alüminyum

Katalogdaki profil ağırlıkları teoriktir. Teslimat öncesi ölçülen değerler geçerlidir.
Profile weights at the catalogue are theoretical, pre-shipment values will be valid.



smart.cam.balkon



+90 534 292 6222

SÜRME SİSTEM

ECO SLİM SÜRME SİSTEM PROFİLLERİ



SMART
ALÜMİNYUM

PROFİLLER / PROFILES

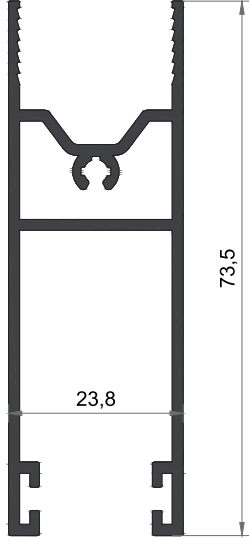

1700-309

AĞIRLIK / WEIGHT (KG/M.)
1005 gr / m

BAZA PRF.

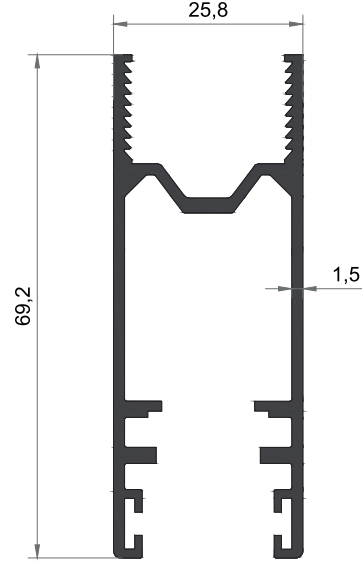

1700-314

AĞIRLIK / WEIGHT (KG/M.)
900 gr / m

KİLİT KOL PRF.

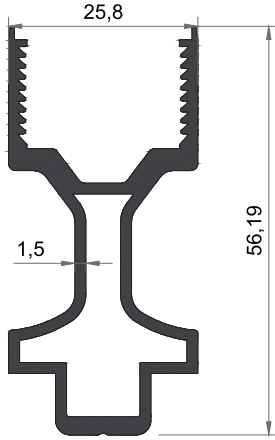

1700-307

AĞIRLIK / WEIGHT (KG/M.)
820 gr / m

TUTMA KOL PRF.

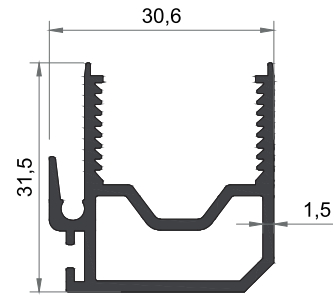

1700-306

AĞIRLIK / WEIGHT (KG/M.)
565 gr / m

KENET PRF.

PROFİLLER / PROFILES

25

Her hakkı saklıdır. Smart Alüminyum izni olmadan kopya edilemez, çoğaltılamaz ve yayımlanamaz.
Copyright © All rights reserved. It shall not be reproduced without permission of Smart Alüminyum

Katalogdaki profil ağırlıkları teoriktir. Teslimat öncesi ölçülen değerler geçerlidir.
Profile weights at the catalogue are theoretical, pre-shipment values will be valid.



smart.cam.balkon



+90 534 292 6222

SÜRME SİSTEM

ECO SLİM SÜRME SİSTEM PROFİLLERİ



SMART
ALÜMİNYUM

PROFİLLER / PROFILES

kod	şekil	tanım	paket metrajı	
SR-01		Kilit Profili Takoza	1L+1R	
SR-02		Tutma Kol Takoza	4	
SR-03		Kenet Takoza (PANÇLI)	8	
SR-04		Kenet Takoza (PANÇSIZ)	4L+4R	
SR-05		Tozluk (pvc)	4	
SR-06		Ayarlı Rulman (pvc)	6 Adet	
SR-07		HAVUZ KOL KİLİT TAKIMI	2 Takım	

PROFİLLER / PROFILES

26

Her hakkı saklıdır. Smart Alüminyum izni olmadan kopya edilemez , çoğaltılamaz ve yayımlanamaz.
Copyright © All rights reserved. It shall not be reproduced without permission of Smart Alüminyum

Katalogdaki profil ağırlıkları teoriktir . Teslimat öncesi ölçülen değerler geçerlidir.
Profile weights at the catalogue are theoretical, pre-shipment values will be valid.



smart.cam.balkon



+90 534 292 6222

SÜRME SİSTEM

ECO SLİM SÜRME SİSTEM PROFİLLERİ



SMART
ALÜMİNYUM

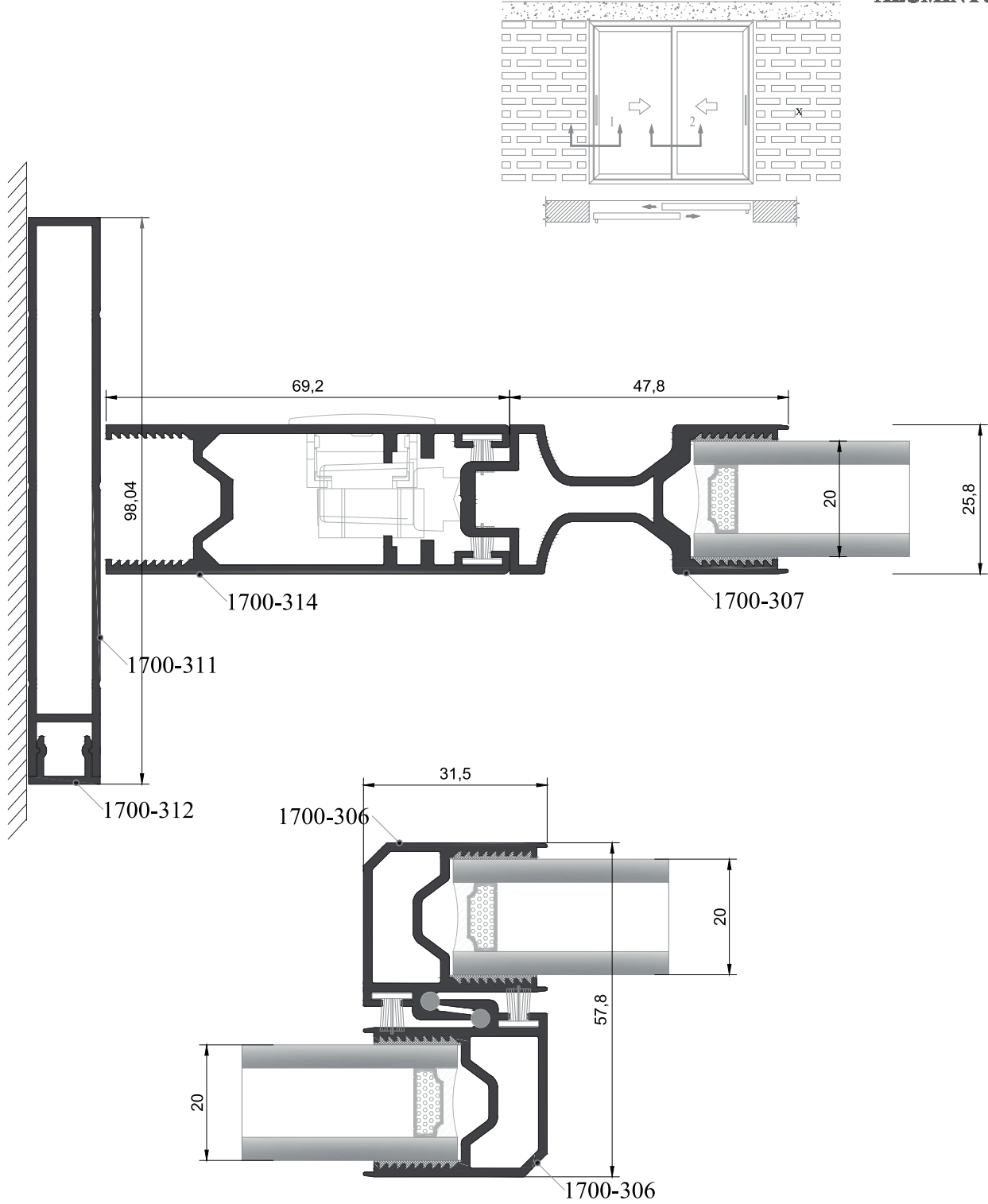

PROFİLLER / PROFILES

28

Her hakkı saklıdır. Smart Alüminyum izni olmadan kopya edilemez, çoğaltılamaz ve yayımlanamaz.
Copyright © All rights reserved. It shall not be reproduced without permission of Smart Alüminyum

Katalogdaki profil ağırlıkları teoriktir. Teslimat öncesi ölçülen değerler geçerlidir.
Profile weights at the catalogue are theoretical, pre-shipment values will be valid.

SÜRME SİSTEM

ECO SLİM SÜRME SİSTEM PROFİLLERİ



SMART
ALÜMİNYUM

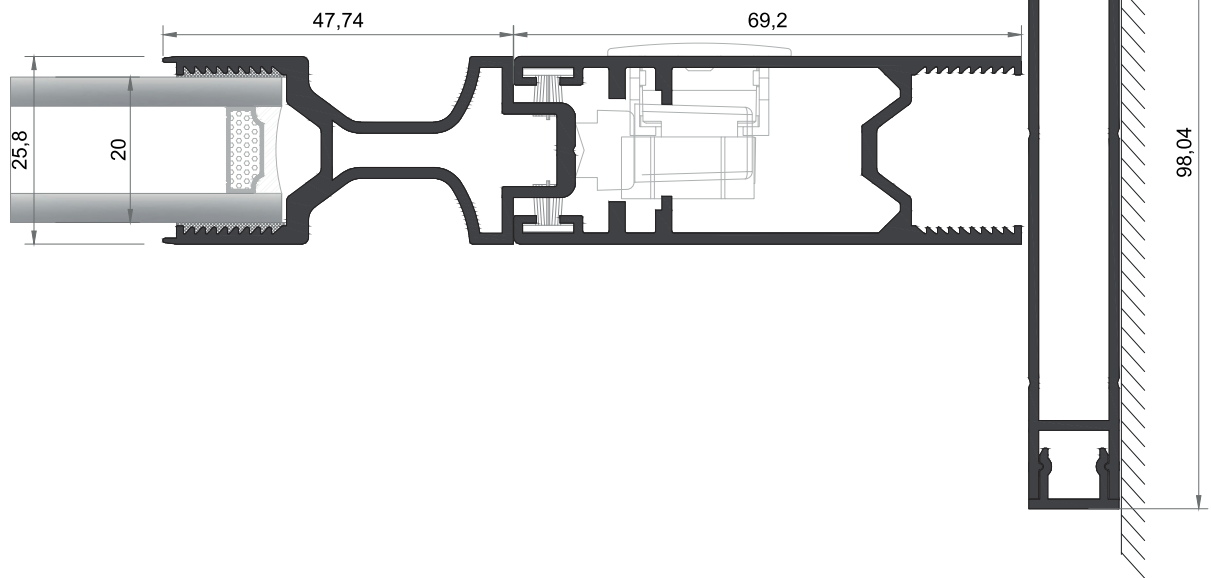
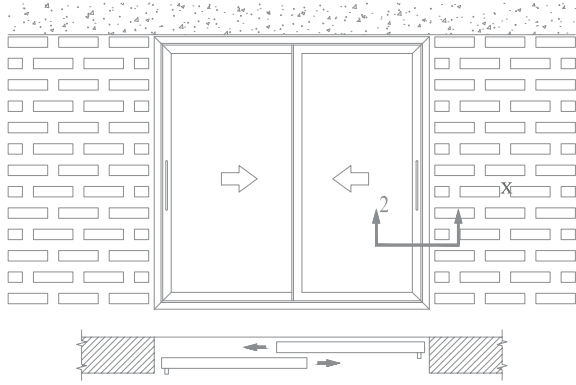
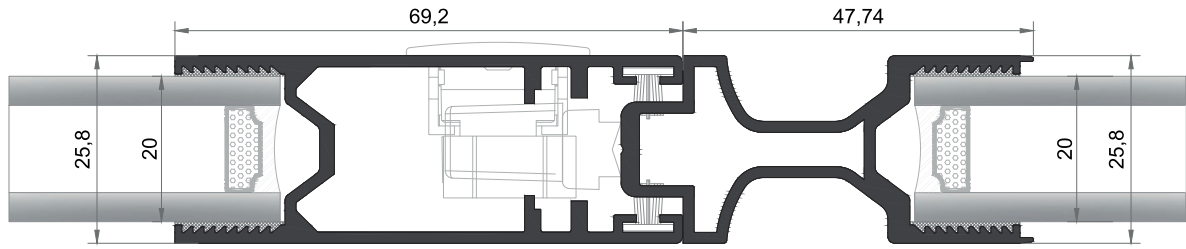
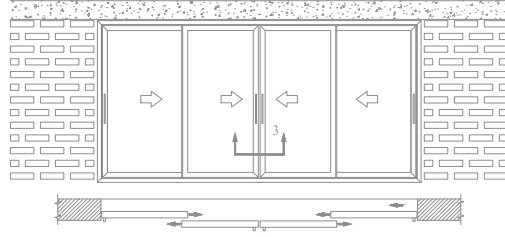

PROFİLLER / PROFILES

29

Her hakkı saklıdır. Smart Alüminyum izni olmadan kopya edilemez, çoğaltılamaz ve yayımlanamaz.
Copyright © All rights reserved. It shall not be reproduced without permission of Smart Alüminyum

Katalogdaki profil ağırlıkları teoriktir. Teslimat öncesi ölçülen değerler geçerlidir.
Profile weights at the catalogue are theoretical, pre-shipment values will be valid.



smart.cam.balkon



+90 534 292 6222

SÜRME SİSTEM

ECO SLİM SÜRME SİSTEM PROFİLLERİ



SMART
ALÜMİNYUM

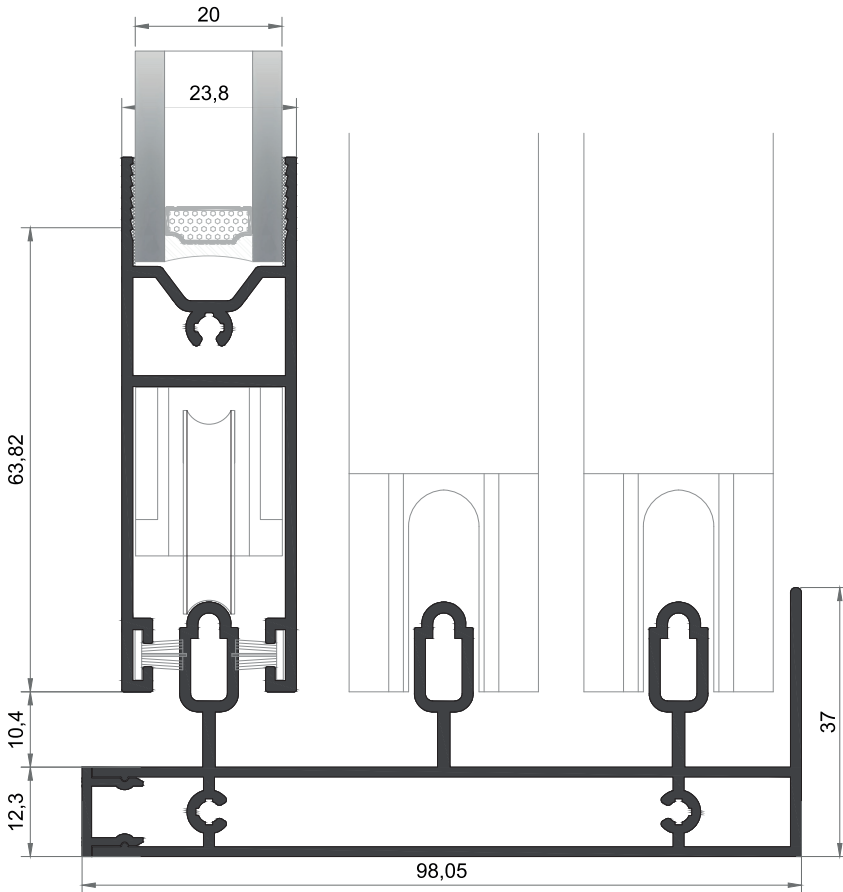
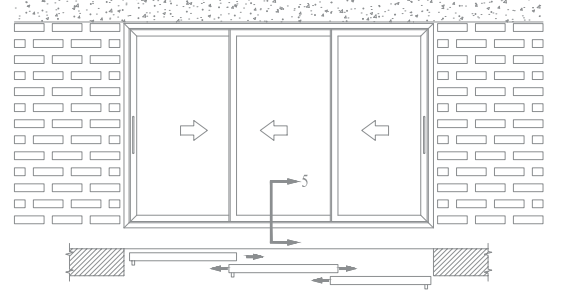
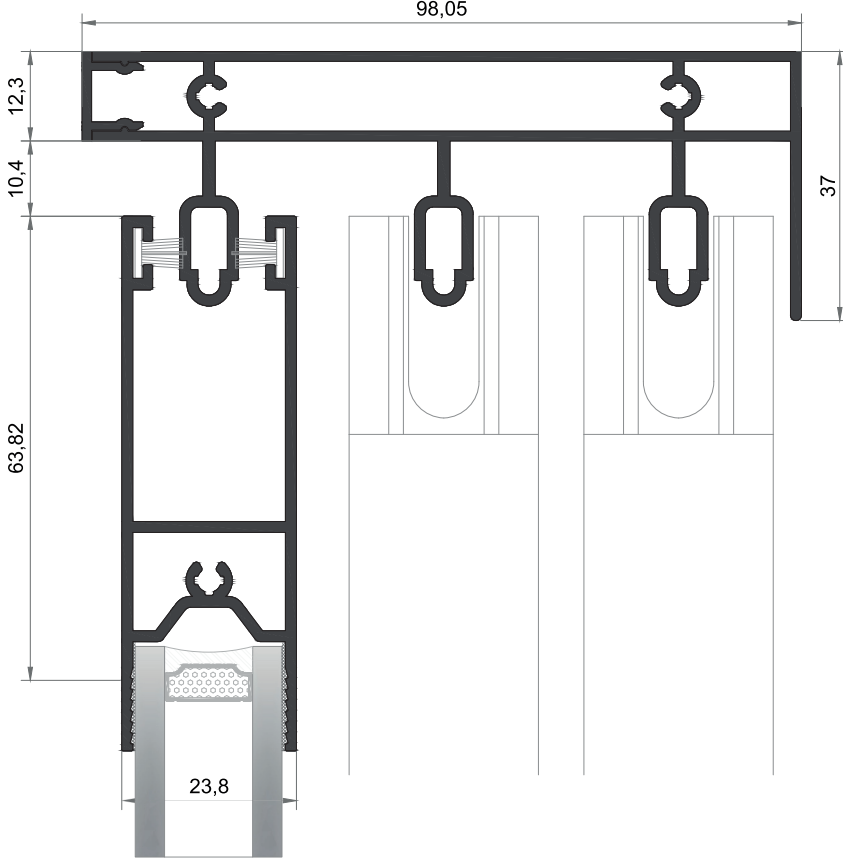

PROFİLLER / PROFILES

30

Her hakkı saklıdır. Smart Alüminyum izni olmadan kopya edilemez, çoğaltılamaz ve yayımlanamaz.
Copyright © All rights reserved. It shall not be reproduced without permission of Smart Alüminyum

Katalogdaki profil ağırlıkları teoriktir. Teslimat öncesi ölçülen değerler geçerlidir.
Profile weights at the catalogue are theoretical, pre-shipment values will be valid.



smart.cam.balkon



+90 534 292 6222

SÜRME SİSTEM

ECO SLİM SÜRME SİSTEM PROFİLLERİ



SMART
ALÜMİNYUM

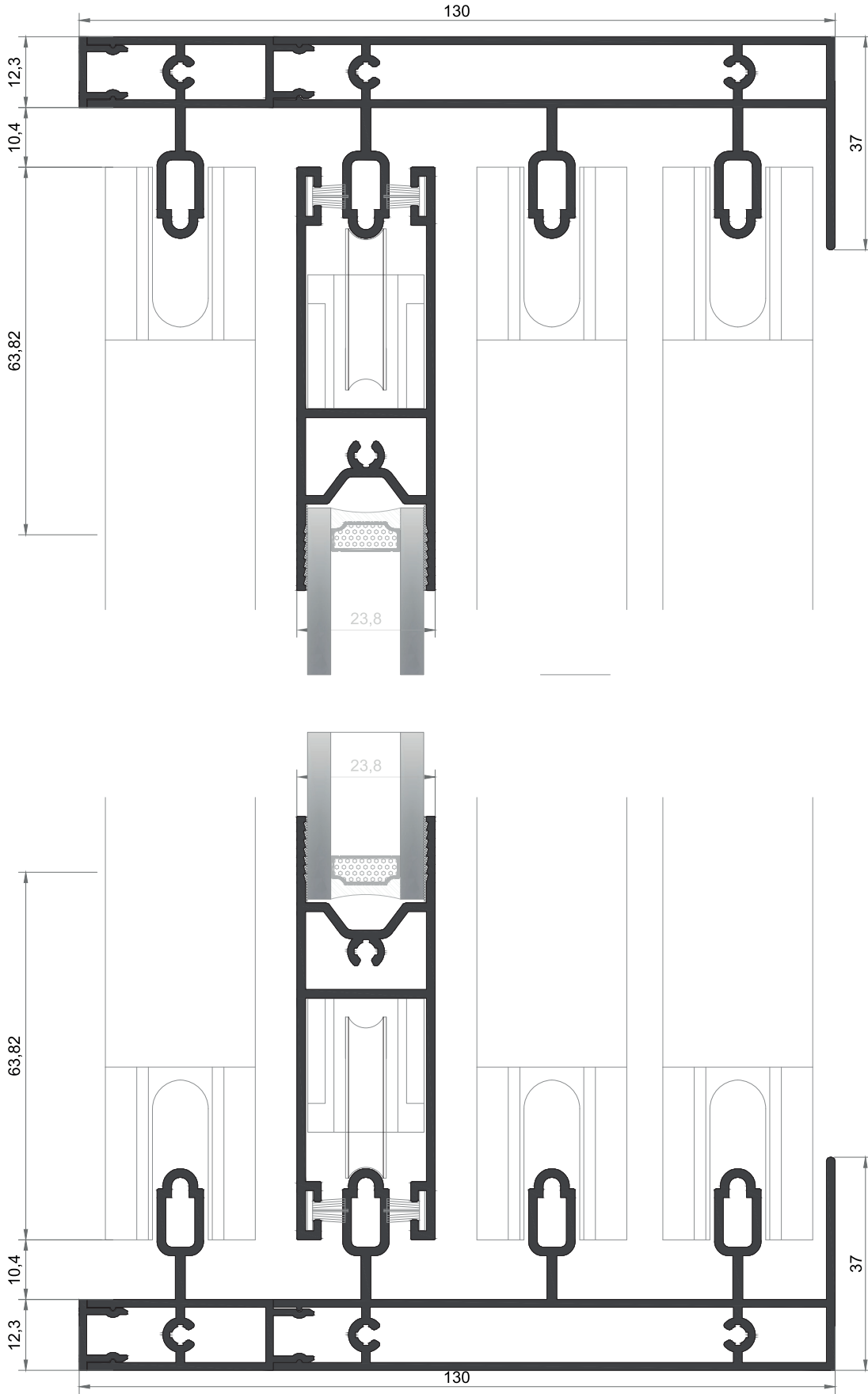

PROFİLLER / PROFILES

31

Her hakkı saklıdır. Smart Alüminyum izni olmadan kopya edilemez, çoğaltılamaz ve yayımlanamaz.
Copyright © All rights reserved. It shall not be reproduced without permission of Smart Alüminyum

Katalogdaki profil ağırlıkları teoriktir. Teslimat öncesi ölçülen değerler geçerlidir.
Profile weights at the catalogue are theoretical, pre-shipment values will be valid.



smart.cam.balkon



+90 534 292 6222

SÜRME SİSTEM

ECO SLİM SÜRME SİSTEM PROFİLLERİ



SMART
ALÜMİNYUM

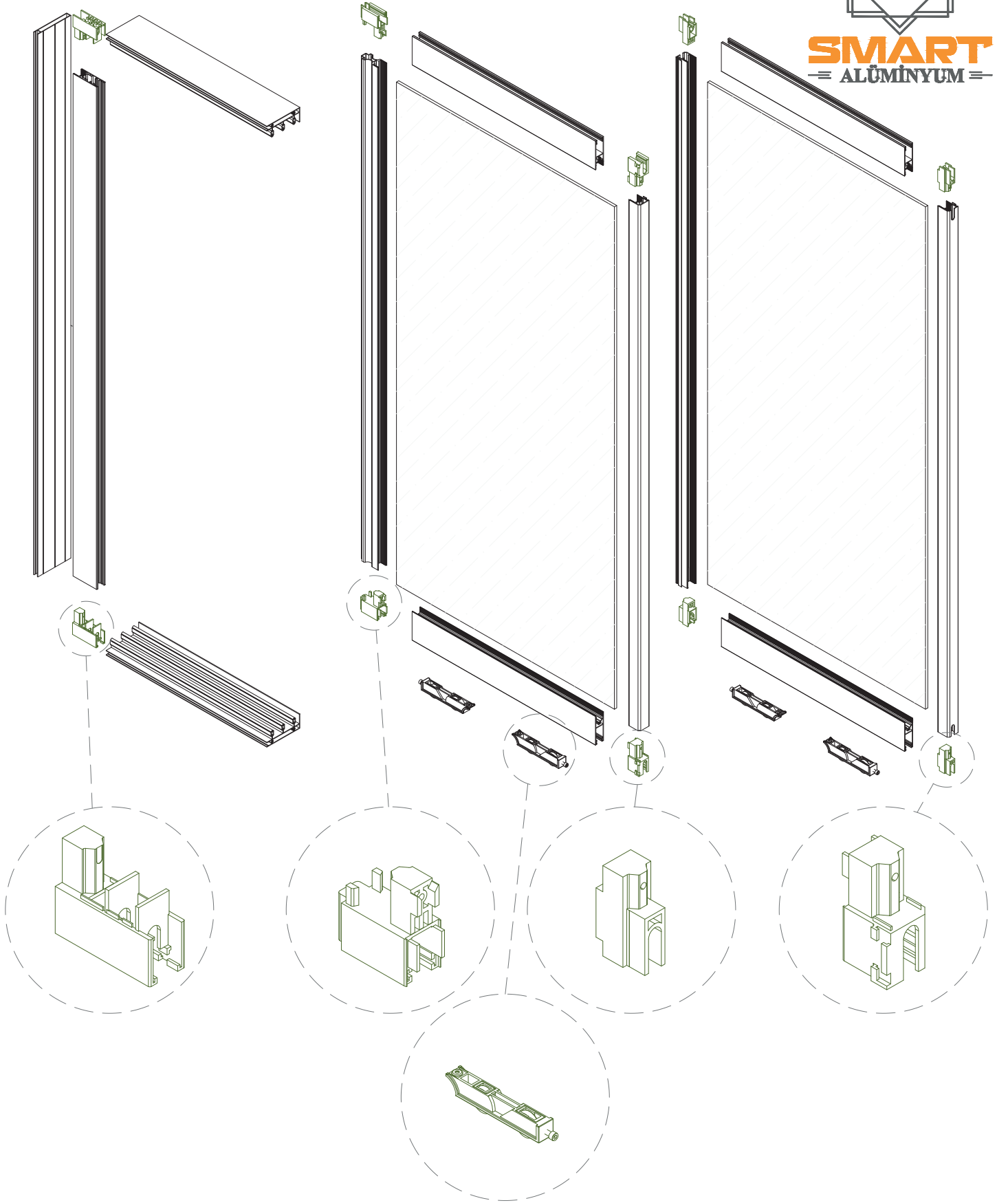

PROFİLLER / PROFILES

32

Her hakkı saklıdır. Smart Alüminyum izni olmadan kopya edilemez, çoğaltılamaz ve yayımlanamaz.
Copyright © All rights reserved. It shall not be reproduced without permission of Smart Alüminyum

Katalogdaki profil ağırlıkları teoriktir. Teslimat öncesi ölçülen değerler geçerlidir.
Profile weights at the catalogue are theoretical, pre-shipment values will be valid.



smart.cam.balkon



+90 534 292 6222

SÜRME SİSTEM

ECO SLİM SÜRME SİSTEM PROFİLLERİ



SMART
ALÜMİNYUM

PROFİLLER / PROFILES

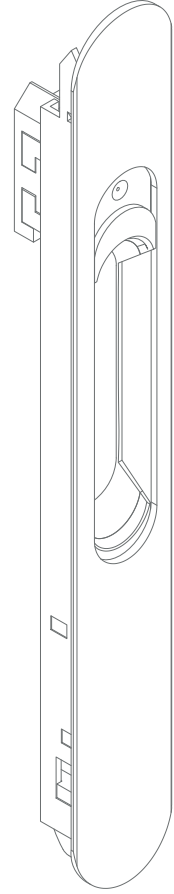
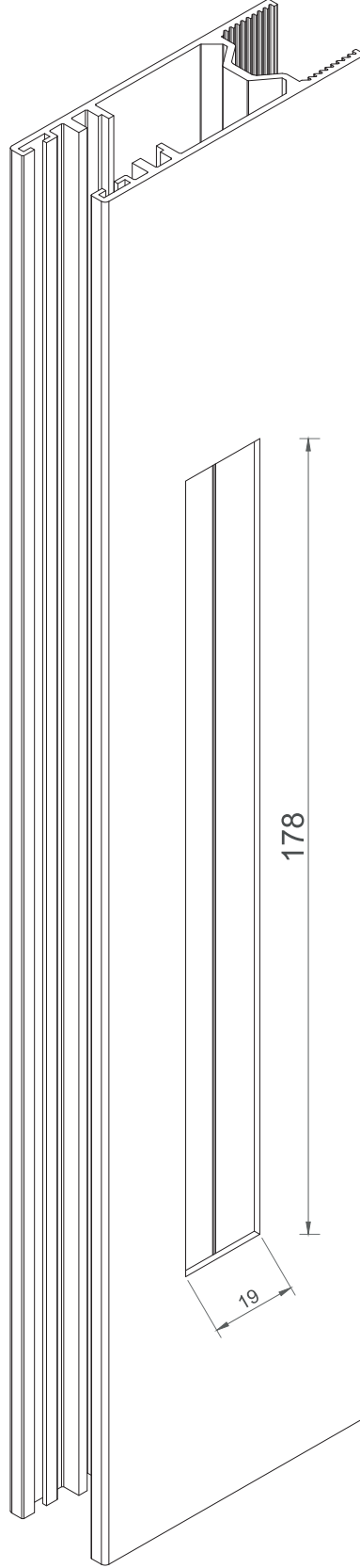
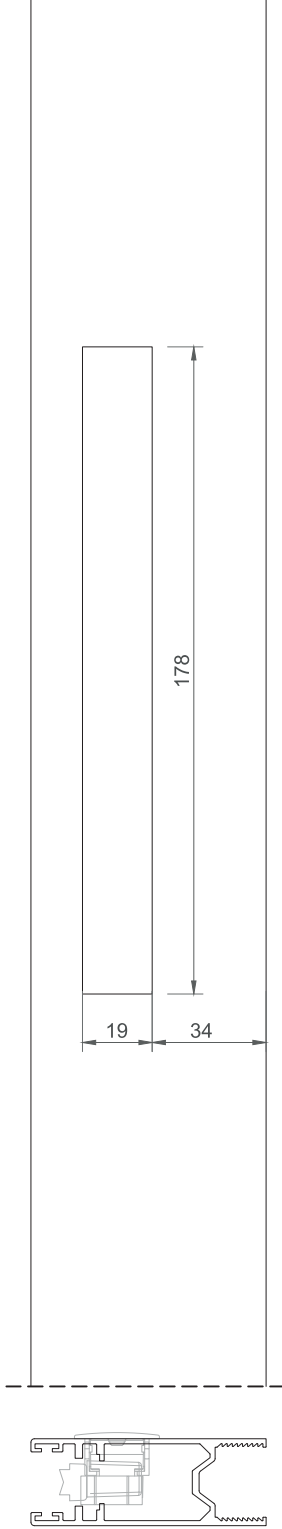

PROFİLLER / PROFILES

33

Her hakkı saklıdır. Smart Alüminyum izni olmadan kopya edilemez, çoğaltılamaz ve yayımlanamaz.
Copyright © All rights reserved. It shall not be reproduced without permission of Smart Alüminyum

Katalogdaki profil ağırlıkları teoriktir. Teslimat öncesi ölçülen değerler geçerlidir.
Profile weights at the catalogue are theoretical, pre-shipment values will be valid.



smart.cam.balkon



+90 534 292 6222

SÜRME SİSTEM

ECO SLİM SÜRME SİSTEM PROFİLLERİ



SMART
ALÜMİNYUM

PROFİLLER / PROFILES

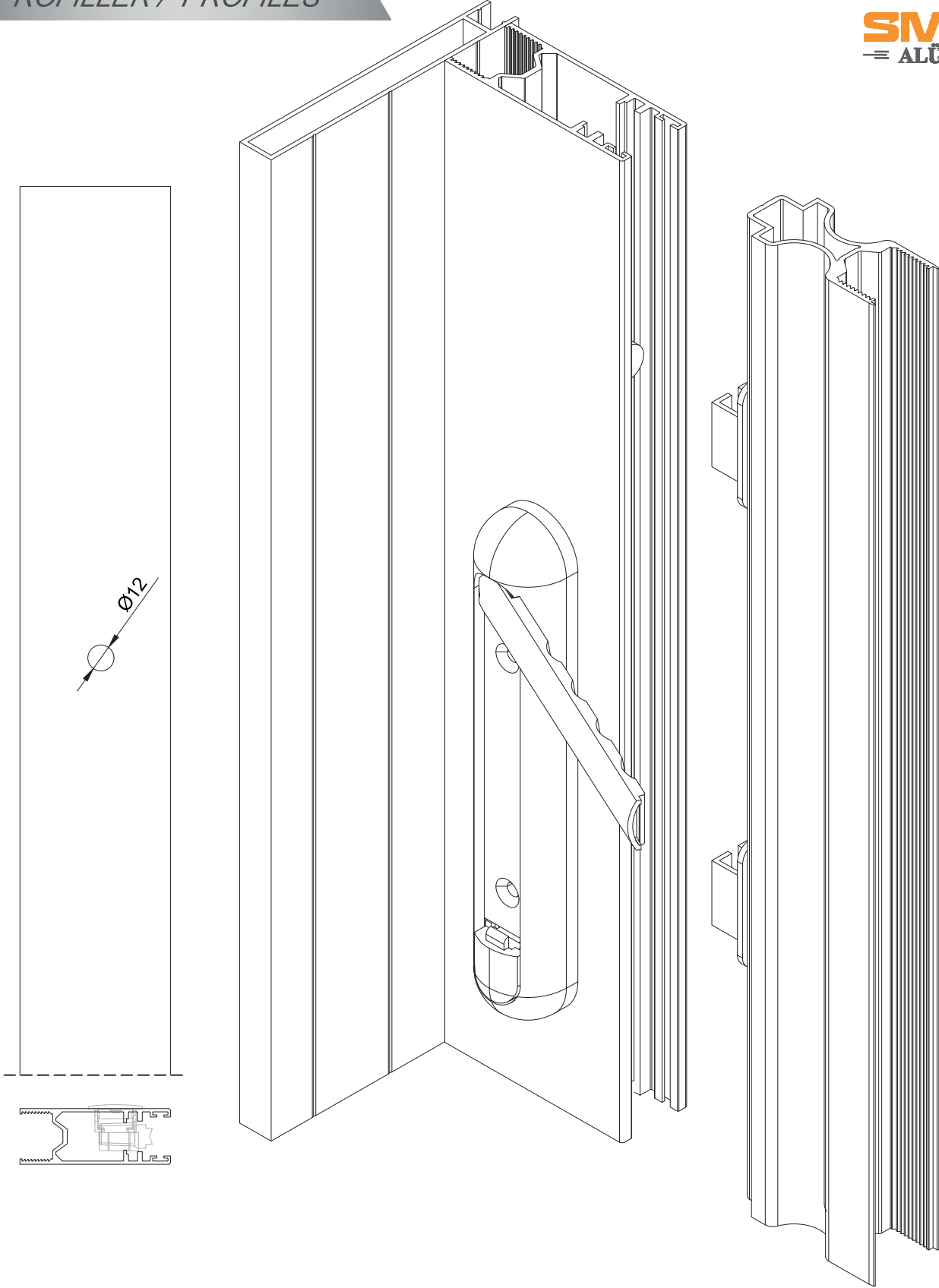

PROFİLLER / PROFILES

34

Her hakkı saklıdır. Smart Alüminyum izni olmadan kopya edilemez, çoğaltılamaz ve yayımlanamaz.
Copyright © All rights reserved. It shall not be reproduced without permission of Smart Alüminyum

Katalogdaki profil ağırlıkları teoriktir. Teslimat öncesi ölçülen değerler geçerlidir.
Profile weights at the catalogue are theoretical, pre-shipment values will be valid.



smart.cam.balkon



+90 534 292 6222



SMART

— CAM BALKON —

ALÜMİNYUM SİSTEMLERİ

BİOKLİMATİK SİSTEMLER

DOĞAYLA UYUMLU
KONFORLU YAŞAM ALANLARI



GÜNEŞ
KONTROLÜ



YAĞMUR
KORUMASI



DOĞAL
HAVALANDIRMA



UZAKTAN
KUMANDA

2026 KATALOG

BİOKLİMATİK
GELECEĞİN YAŞAM ALANLARI



SMART
= ALÜMİNYUM =

Bioklimatik Pergola / Bioclimatic Pergola

10-10911
Oluk Profili / Gutter Profile
3.034 kg/m

10-10910
Oluk Dikme Profili / Gutter Strut Profile
3.562 kg/m

10-10909
Üst L Profili / Top L Profile
0.746 kg/m

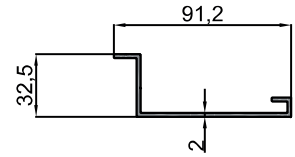
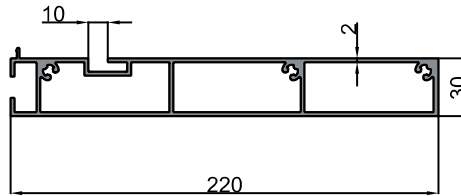
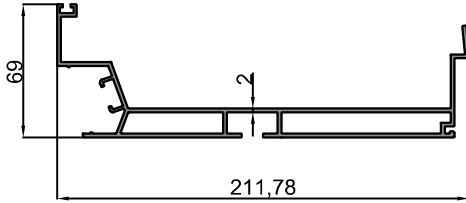

10-10974
Hareketli Ray Profili / Moving Rail Profile
1.493 kg/m

10-10943
Sabit Ray Profili / Stable Rail Profile
4.578 kg/m

10-10942
Ayak Profili / Counterfort Profile
3.841 kg/m

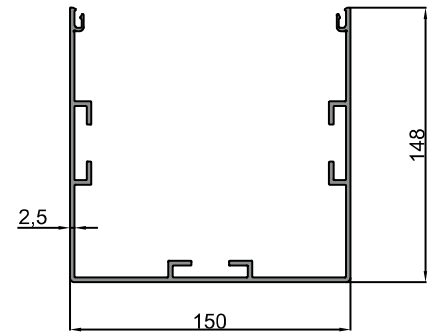
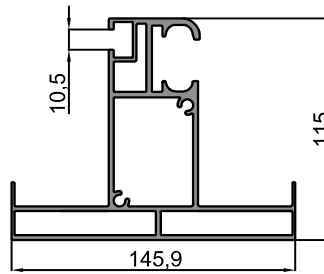
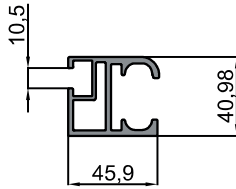

10-10941
Ayak Kapak Profili / Counterfort Cover Profile
0.951 kg/m

10-10921
Panel Profili / Panel Profile
2.898 kg/m

10-10944
Panel Profili / Panel Profile
3.490 kg/m

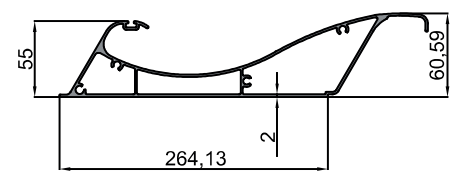
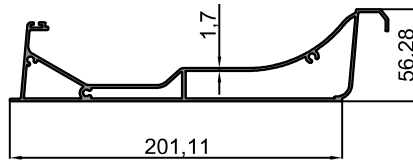
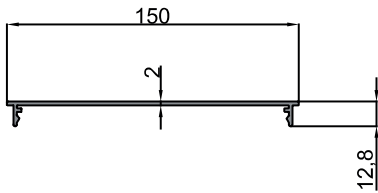



SMART

— CAM BALKON —
ALÜMİNYUM SİSTEMLERİ

DIŞ MEKANLARDA
KONFOR SENİN ELİNDE

PERGOLA TENTE SİSTEMLERİ

GÜNEŞTEN KORUN
YAĞMURDA KULLAN
4 MEVSİM KEYİF



GÜNEŞ KORUMASI
UV dayanımlı
özel tente kumaşı



YAĞMUR DİRENCİ
Su geçirmez
tente sistemi



MOTORLU SİSTEM
Uzaktan kumanda ile
aç / kapa



SAĞLAM YAPI
Alüminyum
taşıyıcı sistem



BAHÇE UYGULAMASI



KAFE / RESTORAN UYGULAMASI



TERAS / BALKON UYGULAMASI



GÖLGELENDİRME
MAKSİMUM KONFOR



UZUN ÖMÜRLÜ
DAYANIKLI SİSTEM



KOLAY KULLANIM
PRATİK ÇÖZÜM



ŞİK TASARIM
MODERN GÖRÜNÜM



smartcambalkon.com



0534 292 62 22



Ovacık Mah. 2034. Sok. No:6B
Alüminyumcular Sitesi KEÇİÖREN/ANKARA

KALİTE
GÜVEN
ÇÖZÜM



SMART
= ALUMINYUM =

Pergola / Pergola

10-10415
Oluk Profili/Gutter Profile
3.383 kg/m

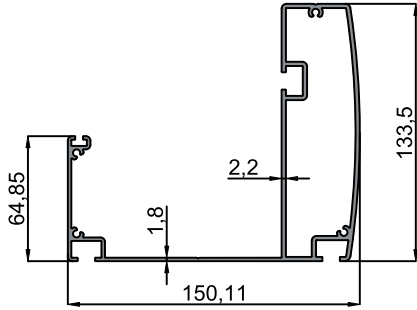

10-10468
Oluk Profili/Gutter Profile
4.006 kg/m

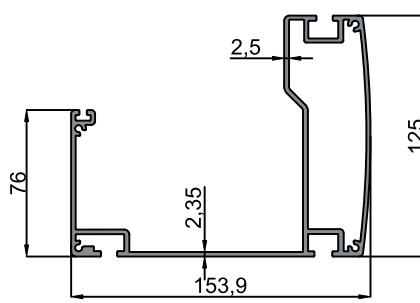

10-10477
Oluk Profili/Gutter Profile
4.397 kg/m

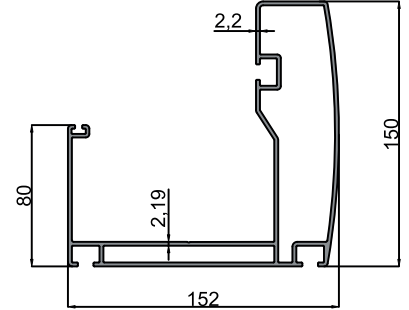

10-10513
Oluk Profili/Gutter Profile
3.411 kg/m

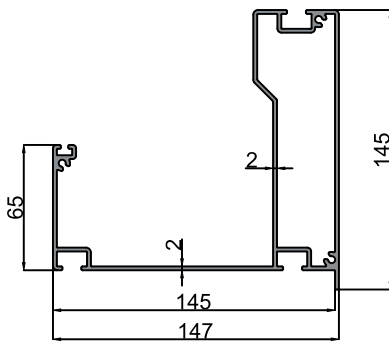

10-10412
70x150 mm Ray Profili/ 70x150 mm Rail Profile
3.094 kg/m

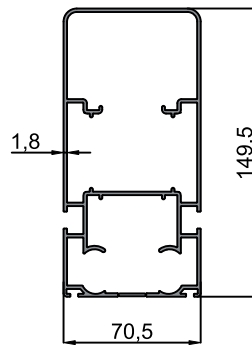

10-10469
70x150 mm Ray Profili/
70x150 mm Rail Profile
4.100 kg/m

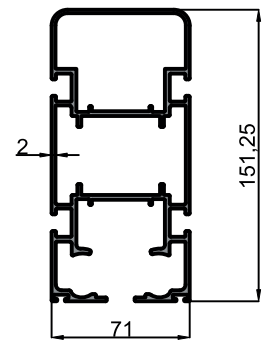

10-10411
90x150 Ray Profili/ 90x150 mm Rail Profile
5.114 kg/m

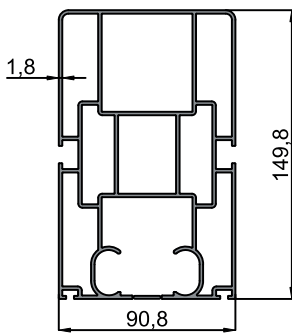

10-10501
90x150 Ray Profili/ 90x150 mm Rail Profile
4.129 kg/m

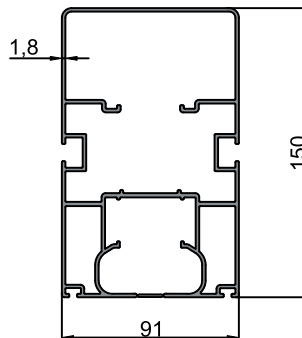

10-10475
110x150 mm Ray Profili/
110x150 mm Rail Profile
7.116 kg/m

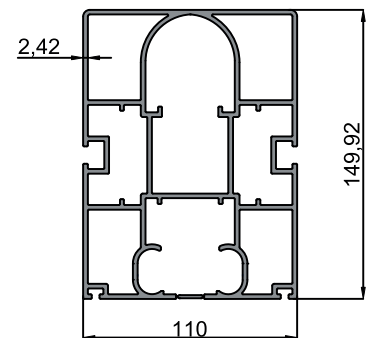

10-10612
110x150 mm Ray Profili/ 110x150 mm Rail Profile
5.214 kg/m

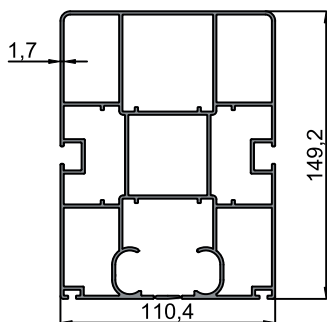

10-10541
80x130 mm Ray Profili/ 80x130 mm Rail Profile
3.613 kg/m

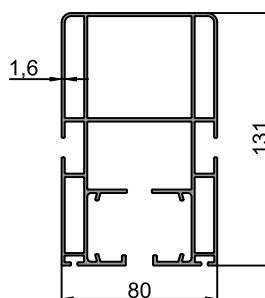

10-10414
100'lük Ayak Profili/ Counterfort Profile
2.227 kg/m

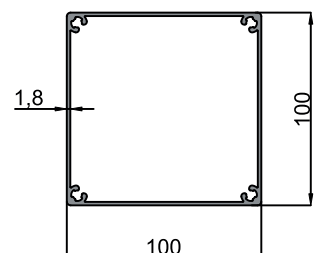

Pergola / Pergola

10-10419
144'lük Ayak Profili/ Counterfort Profile
2.927 kg/m

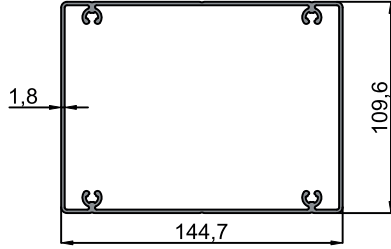

10-10420
Orta Kayıt Profili/ Vertical Meeting Profile
1.355 kg/m

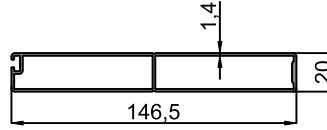

10-10416
Kalın Korniş Profili/ Thick Stringcourse Profile
1.288 kg/m

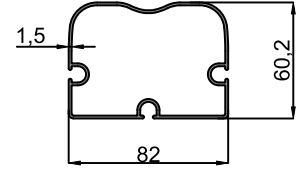

10-10418
İnce Korniş Profili/ Thin Stringcourse Profile
0.737 kg/m

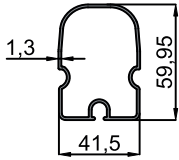

10-10472
Kalın Korniş Profili/ Thick Stringcourse Profile
1.491 kg/m

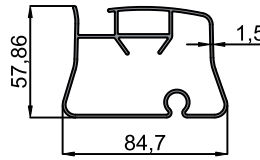

10-10471
İnce Korniş Profili/ Thin Stringcourse Profile
0.809 kg/m

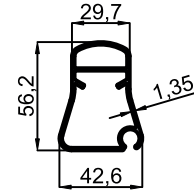

10-10470
İnce Korniş Ek Profili/
Thick Stringcourse Joint Profile
0.590 kg/m

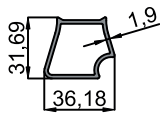

10-10610
Kapaklı İnce Korniş Profili/
Thick Stringcourse Cover Profile With Cover
0.679 kg/m

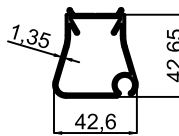

10-10611
Kapaklı İnce Korniş Kapağı Profili/
Thick Stringcourse Cover Profile With Cover
0.162 kg/m

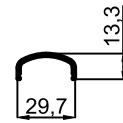

10-10417
Tambur Boru Profili/ Bull Block Tube Profile
1.071 kg/m

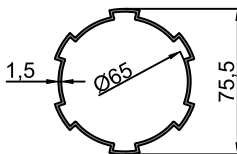

10-10467
Tambur Boru Profili/ Bull Block Tube Profile
1.213 kg/m

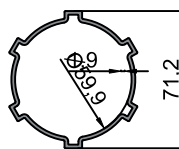

Pergola / Pergola

43-5209
Mafsallı Tente Profili/
Articulated Awning Profile
0.791 kg/m

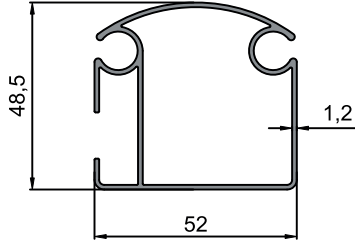

43-5211
Mafsallı Tente Profili/
Articulated Awning Profile
0.214 kg/m

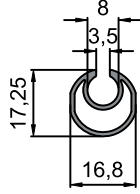

10-10607
Mafsallı Tente Profili/
Articulated Awning Profile
0.528 kg/m

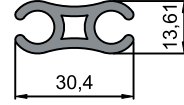

10-10608
Mafsallı Tente Profili/
Articulated Awning Profile
0.412 kg/m

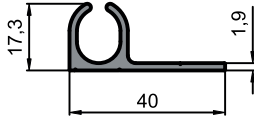

10-10609
Mafsallı Tente Profili/
Articulated Awning Profile
1.232 kg/m

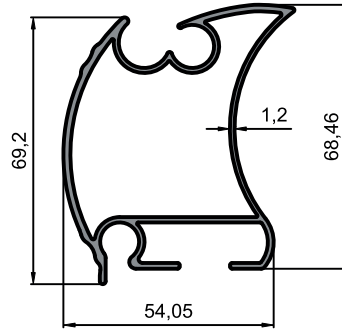







SMART

— CAM BALKON —

ALÜMİNYUM SİSTEMLERİ

YAŞAM ALANINIZI
**IŞIKLA
BÜYÜTÜN!**

CAM TAVAN SİSTEMLERİ

-  **MAKSİMUM IŞIK**
Doğal aydınlık alanlar
-  **SU GEÇİRMEZ**
Tam koruma
-  **DAYANIKLI**
Güçlü alüminyum yapı
-  **UZAKTAN KUMANDA**
Akıllı kontrol sistemi

2026
KATALOG





SMART
ALUMINYUM

Cam Tavan / Glass Ceiling

10-10094
Oluk Profili / Gutter Profile
4.849 kg/m

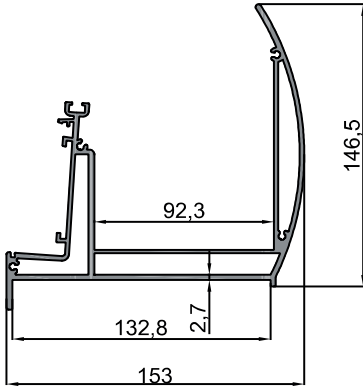

10-10281
Oluk Profili / Gutter Profile
5.315 kg/m

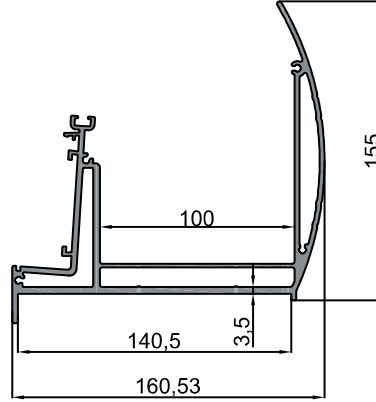

10-10093
Duvar Profili / Wall Profile
1.942 kg/m



10-10285
Duvar ve Oluk Profili İç Kapağı
/Wall and Gutter Profile Inside Cover
0.577 kg/m

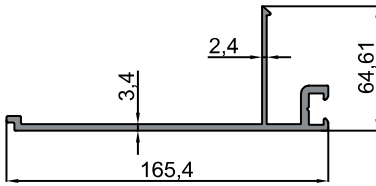

10-10284
Oluk Profili Dış Kapağı
/Gutter Profile Outside Cover
1.402 kg/m

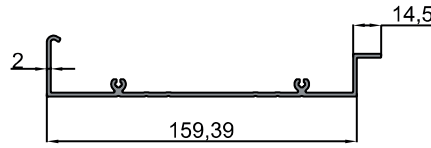

10-10097
Polikarbon Taşıyıcı Profil
/Polycarbonate Carrier Profile
1.851 kg/m

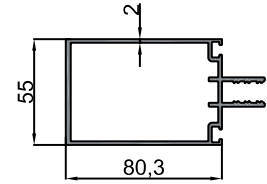

10-10098
Cam Taşıyıcı Profil/Glazing Carrier Profile
2.194 kg/m

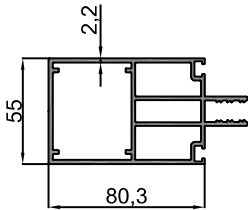

10-10099
Taşıyıcı Profil Orta Kapağı
Carrier Profile Middle Cover
0.472 kg/m

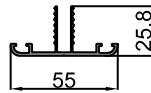

10-10100
Taşıyıcı Profil Yan Kapağı
Carrier Profile Side Cover
0.659 kg/m

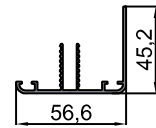

10-10101
Kutu Profili / Rectangular Tube Profile
1.582 kg/m

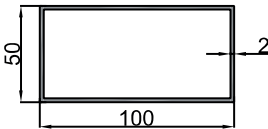

10-10091
Polikarbon Kapama Çıtasa Profili
Polycarbonate Cover Strip Profile
0.252 kg/m

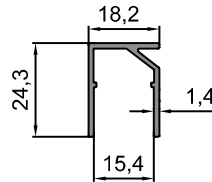

10-10559
Polikarbon Kapama Çıtasa Profili
Polycarbonate Cover Strip Profile
0.210 kg/m

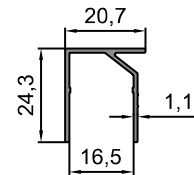

10-10090
H Profili / H Profile
0.505 kg/m

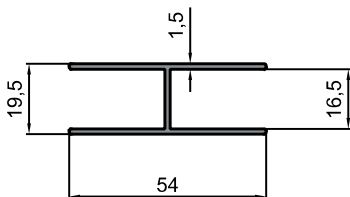

10-10095
Ayak Profili / Counterfort Profile
2.046 kg/m

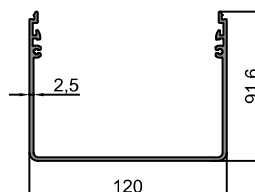

10-10096
Ayak Kapak Profili
Counterfort Cover Profile
1.220 kg/m

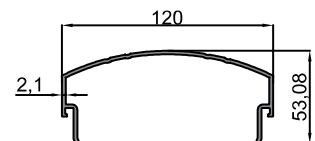



Cam Tavan / Glass Ceiling

SMART
ALUMİNYUM

10-10283
Ayak Profili / Counterfort Profile
4.237 kg/m

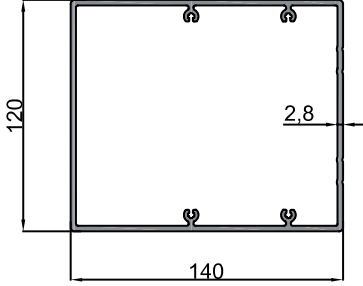

10-10291
Duvar Destek Profili
Wall Back Up Profile
4 998 kg/m

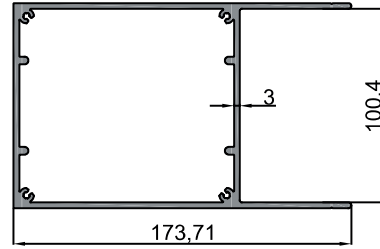

10-10522
Oluk Profili E / Gutter Profile E
4.340 kg/m

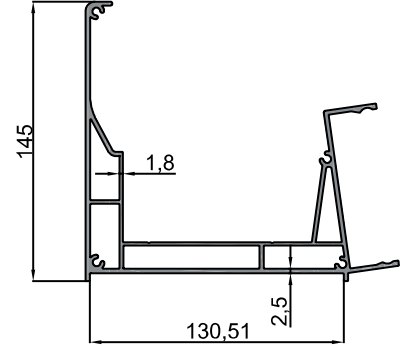

10-10533
Oluk Profili L / Gutter Profile L
6.704 kg/m

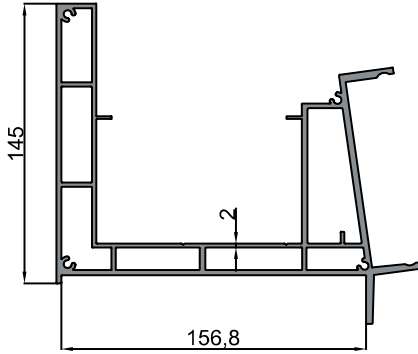

10-10537
Duvar Profili E / Wall Profile E
2.250 kg/m

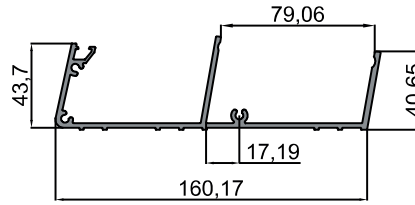

10-10528
Duvar Profili L / Wall Profile L
2.252 kg/m

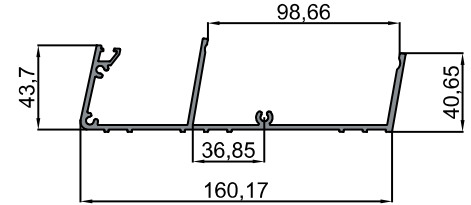

10-10536
Duvar ve Oluk Profili İç Kapağı E
Wall and Gutter Profile Inside Cover E
0.506 kg/m

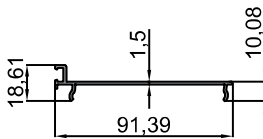

10-10529
Duvar ve Oluk Profili İç Kapağı L
Wall and Gutter Profile Inside Cover L
0.585 kg/m

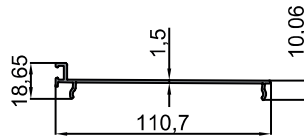

10-10535
Polikarbon Taşıyıcı Profil E
Polycarbonate Carrier Profile E
1.782 kg/m

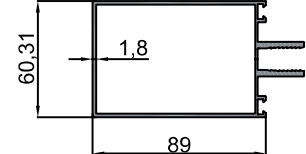

10-10525
Polikarbon Taşıyıcı Profil L
Polycarbonate Carrier Profile L
1.965 kg/m

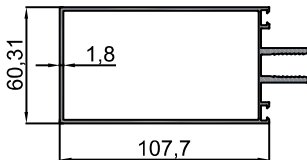

10-10534
Cam Taşıyıcı Profil E
Glazing Carrier Profile E
2 691 kg/m

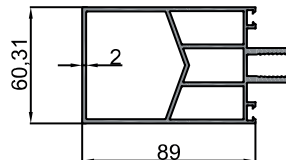

10-10524
Cam Taşıyıcı Profil L
Glazing Carrier Profile L
2 914 kg/m

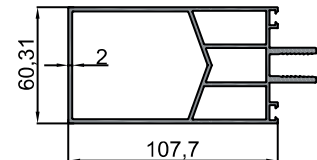

10-10526
Taşıyıcı Profil Orta Kapağı E-L
Carrier Profile Middle Cover E-L
0.677 kg/m

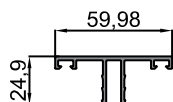

10-10527
Taşıyıcı Profil Yan Kapağı E-L
Carrier Profile Side Cover E-L
0 870 kg/m

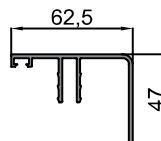



SMART
ALUMINYUM

Cam Tavan / Glass Ceiling

10-10523
Ayak Profili E / Counterfort Profile E
3.901 kg/m

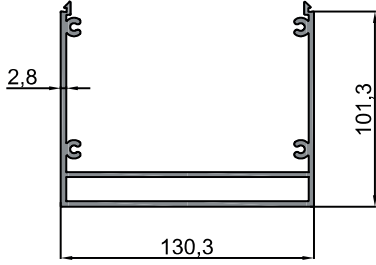

10-10542
Ayak Profili L / Counterfort Profile L
4.608 kg/m

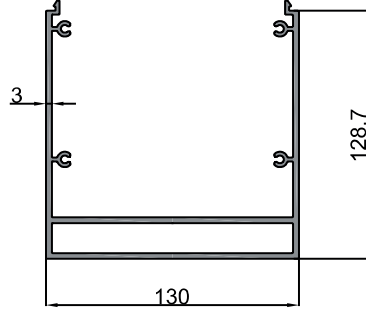

10-10532
Ayak Kapak Profili E
Counterfort Cover Profile E
1.341 kg/m

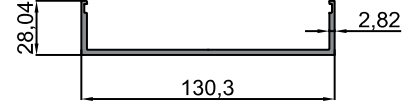

10-10538
Ayak Kapak Profili Uzun L
Counterfort Cover Profile Long L
1.741 kg/m

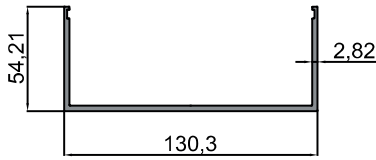

10-10560
Ayak Kapak Profili Kısa L
Counterfort Cover Profile Short L
1.312 kg/m

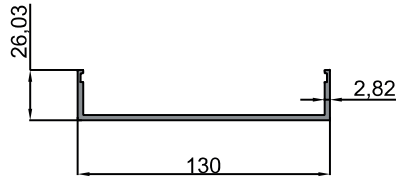

10-10546
Statik Kapak Profili / Static Cover Profile
0.842 kg/m

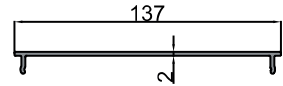

10-10545
Statik Profili / Static Profile
7.409 kg/m

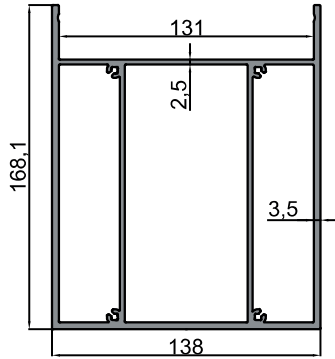

10-10057
Oluk Profili / Gutter Profile
5.704 kg/m

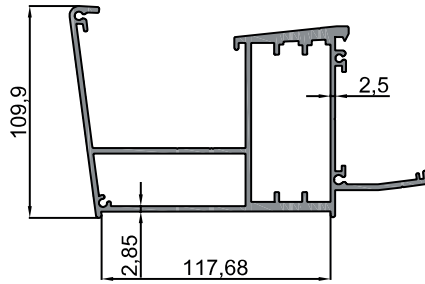

10-10059
Duvar Profili / Wall Profile
1.983 kg/m

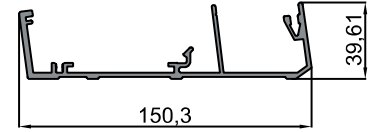

10-10060
Duvar ve Oluk Profili Kapağı
Wall and Gutter Profile Cover
0.744 kg/m

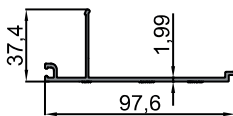

10-10058
Taşıyıcı Profil/Carrier Profile
3.140 kg/m

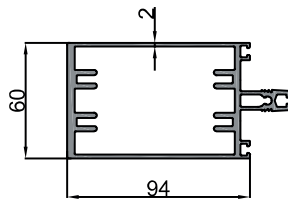

10-10062
Taşıyıcı Profil Orta Kapağı
Carrier Profile Middle Cover
0.557 kg/m

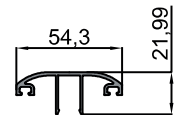

10-10061
Taşıyıcı Profil Yan Kapağı
Carrier Profile Side Cover
0.754 kg/m

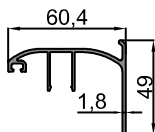

10-10103
Ayak Profili / Counterfort Profile
3.352 kg/m

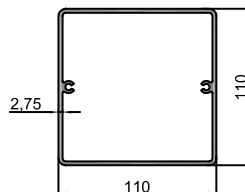

10-10448
Oluk Profili / Gutter Profile
4.930 kg/m

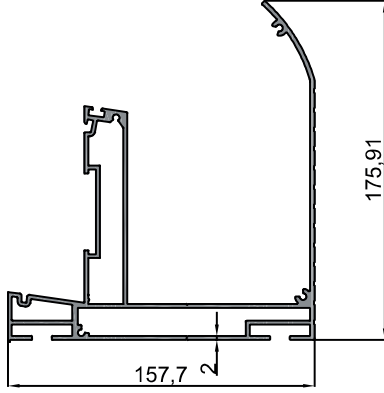

10-10450
Duvar Profili / Wall Profile
2.572 kg/m

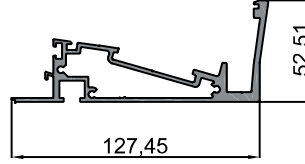

10-10454
Duvar Baskı Profili / Wall Crush Profile
0.787 kg/m

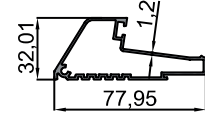

10-10455
Oluk ve Duvar Profili Kapağı
Gutter and Wall Cover Profile
0.544 kg/m

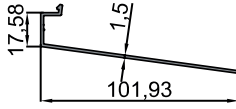

10-10451
Cam Taşıyıcı Profil / Glazing Carrier Profile
2.362 kg/m

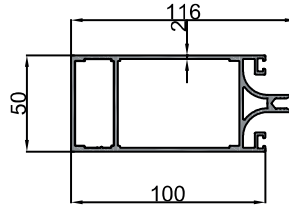

10-10452
Cam Tutucu Profil / Glazing Stop Profile
0.436 kg/m

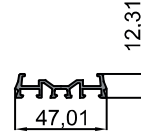

10-10456
Cam Tutucu Orta Kapak Profili
Glazing Stop Middle Cover Profile
0.290 kg/m

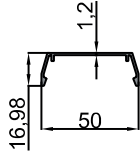

10-10457
Cam Tutucu Yan Kapak Profili
Glazing Stop Side Cover Profile
0.436 kg/m

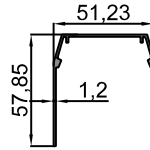

10-10453
Ayak Profili / Counterfort Profile
3.117 kg/m

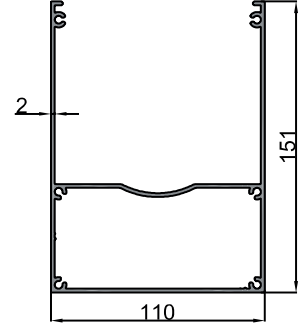

10-10449
Ayak Kapak Profili
Counterfort Cover Profile
0.563 kg/m

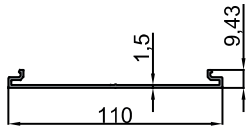

Cam Tavan / Glass Ceiling

10-10549
Oluk Profili / Gutter Profile
5.960 kg/m

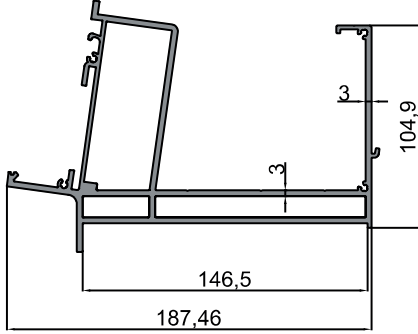

10-10548
Oluk Ön Kapak Profili /
Gutter Front Cover Profile
1.255 kg/m

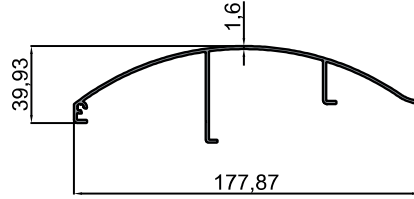

10-10558
Oluk Ön Kapak Profili /
Gutter Front Cover Profile
1.078 kg/m

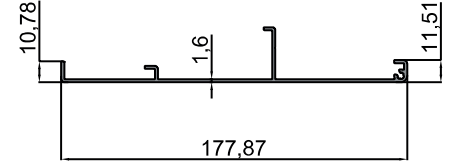

10-10553
Duvar Profili / Wall Profile
2.258 kg/m

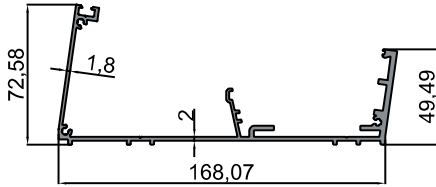

10-10557
Oluk ve Duvar Profili Kapağı
Gutter and Wall Cover Profile
0.613 kg/m

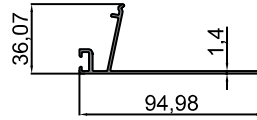

10-10550
Polikarbon Taşıyıcı Profil
Polycarbonate Carrier Profile
2.023 kg/m

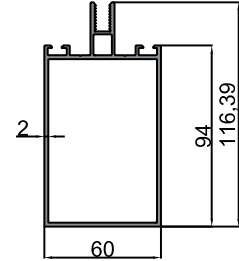

10-10555
Cam Taşıyıcı Profil / Glazing Carrier Profile
2.365 kg/m

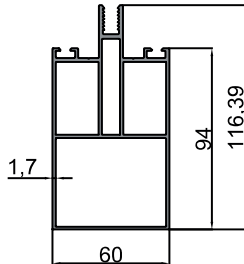

10-10551
Taşıyıcı Profil Orta Kapağı
Carrier Profile Middle Cover
0.450 kg/m

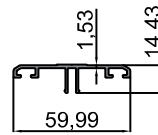

10-10556
Taşıyıcı Profil Yan Kapağı
Carrier Profile Side Cover
0.531 kg/m

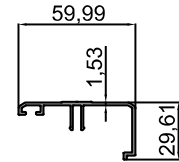

10-10554
Ayak Profili / Counterfort Profile
3.076 kg/m

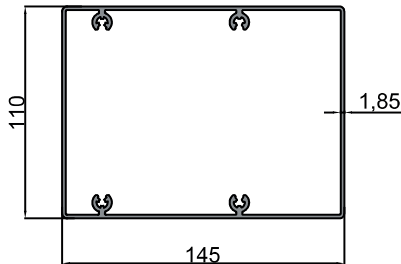



SMART

— CAM BALKON —
ALÜMİNYUM SİSTEMLERİ

MODERN MİMARİDE
GÜÇ VE ESTETİK

C60

SERİSİ
ALÜMİNYUM
DOĞRAMA SİSTEMLERİ

Yüksek dayanım, şık tasarım ve üstün yalıtım performansı ile C60 serisi, yaşam alanlarınıza modern bir dokunuş kazandırır.



YÜKSEK DAYANIM

Güçlü profil yapısı ile uzun ömürlü kullanım



ISI YALITIMI

Enerji tasarrufu sağlayan yüksek yalıtım performansı



SES YALITIMI

Dış ortam gürültüsünü minimuma indirir



SU VE RÜZGAR DİRENCİ

Zorlu hava koşullarına karşı mükemmel koruma sağlar



VİLLA
UYGULAMASI



KONUT
UYGULAMASI



TİCARİ
ALANLAR



MİMARİ
DETAYLAR



smartcambalkon.com



0534 292 62 22



Ovacık Mah. 2034. Sok. No:6B
Alüminyumcular Sitesi KEÇİÖREN/ANKARA

KALİTE
GÖVEN
ÇÖZÜM

C60 Serisi / C60 Series

11-2268
Dar Kasa Profili / Narrow Frame Profile
1.016 kg/m

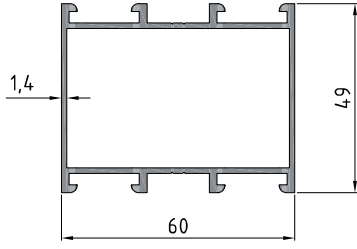

11-2269
Kanat Profili / Sash Profile
1.060 kg/m

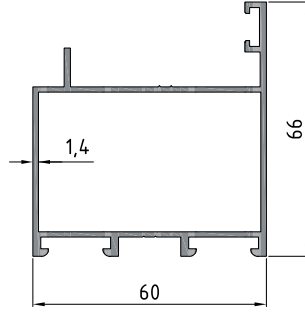

11-2266
Geniş Kasa Profili / Wide Frame Profile
1 316 kg/m

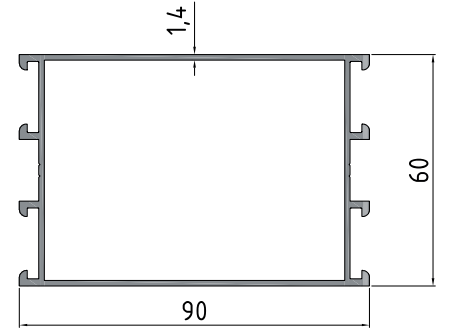

11-2270
Etek Profili / Plinth Profile
1.542 kg/m

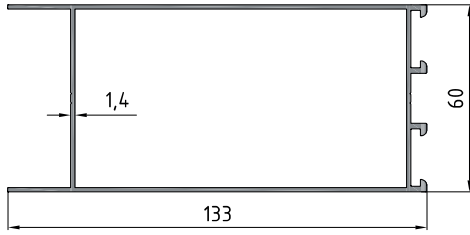

11-2256
Kanat Adaptörü / Sash Adaptor
0.462 kg/m

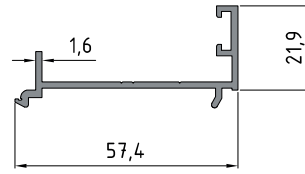

11-2261
Çarpma Kapı Adaptörü /
Swinging Door Adaptor
0.401 kg/m

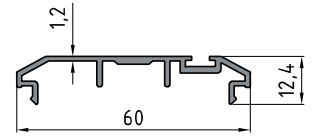

11-2254
İsıcam Çıtası / Double Glazing Strip
0.281 kg/m

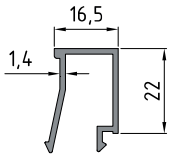

11-2255
Tek Cam Çıtası / Single Glazing Strip
0 268 kg/m

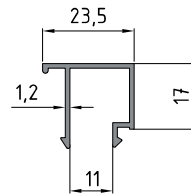



SMART
— CAM BALKON —
ALÜMİNYUM SİSTEMLERİ

ALDOKS

ALÜMİNYUM

DOĞRAMA SİSTEMLERİ

Modern mimarinin ihtiyaçlarına uygun, estetik, güvenli ve dayanıklı Aldoks alüminyum doğrama sistemleri ile yaşam alanlarınıza değer katıyoruz.



YÜKSEK DAYANIM
Güçlü profil yapısı ile uzun ömürlü kullanım



ISI YALITIMI
Enerji tasarrufu sağlayan yüksek yalıtım performansı



SES YALITIMI
Dış ortam gürültüsünü minimuma indirir



SU YALITIMI
Özel conta sistemi ile mükemmel su sızdırmazlığı



RÜZGAR DİRENCİ
Zorlu hava koşullarına karşı maksimum koruma sağlar



GÜVENLİK
Yüksek güvenli kilit sistemleri ile tam koruma



ALDOKS
SERİSİ
ESTETİK • GÜVENLİK • KONFOR



VİLLA UYGULAMASI



KONUT UYGULAMASI



TİCARİ ALAN UYGULAMASI



OFİS UYGULAMASI



UZUN ÖMÜRLÜ
SİSTEMLER



ELEKTROSTATİK
TOZ BOYA



KOLAY MONTAJ
PRATİK ÇÖZÜM



ÇEVRE DOSTU
SÜRDÜRÜLEBİLİR

KALİTE
GÜVEN
ÇÖZÜM

smarcambalkon.com

[0534 292 62 22](tel:05342926222)

[Ovacık Mah. 2034. Sok. No:6B](#)
Alüminyumcular Sitesi KEÇİÖREN/ANKARA



SMART
ALUMINYUM

Aldoks Serisi / Aldox Series

41-1946

Kasa Profili / Frame Profile

0.623 kg/m

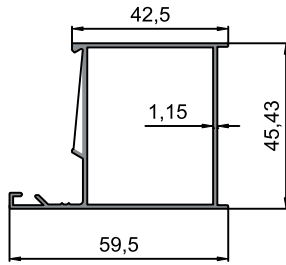

41-1989

Kanat Profili / Sash Profile

0.718 kg/m

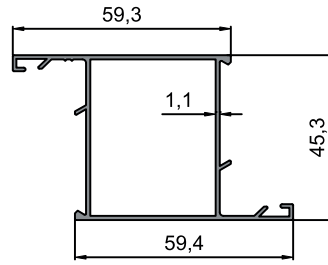

41-1990

Orta Kayıt Profili / Transom Profile

0.714 kg/m

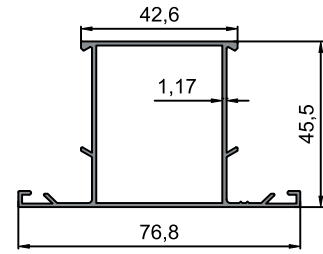

41-1948

Tek Cam Çıta / Single Glazing Beam

0.210 kg/m

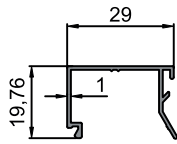

41-1949

Isı Cam Çıta / Double Glazing Beam

0.234 kg/m

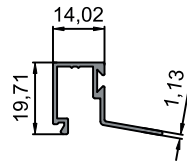

10-1950

Köşe Takozu / Corner Wedge

1.165 kg/m

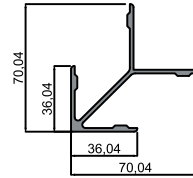

41-10303

Lambiri Profili / Wainscot Profile

1.347 kg/m

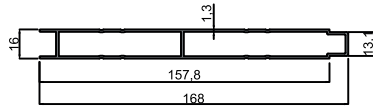

41-10290

Lambiri Profili / Wainscot Profile

1.281 kg/m

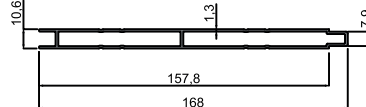

41-1954

Lambiri Profili / Wainscot Profile

0.534 kg/m

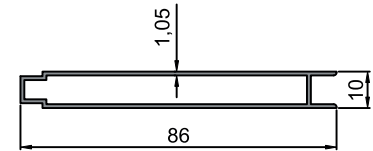

41-10561

Lambiri Profili / Wainscot Profile

1.656 kg/m

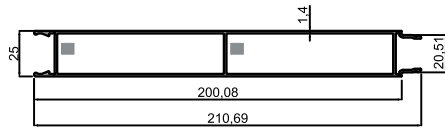

10-10090

H Profil / H Profile

0.505 kg/m

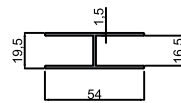

10-10089

F Profil / F Profile

0.508 kg/m

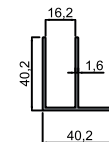

10-10562

F Profil / F Profile

0.438 kg/m

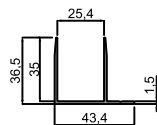

10-10563

H Profil / H Profile

0.483 kg/m

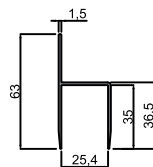



SMART
— CAM BALKON —
ALÜMİNYUM SİSTEMLERİ

CEPHE SİSTEMLERİ

MODERN MİMARİNİN
GÜÇLÜ YÜZÜ

Estetik tasarım, yüksek dayanım ve üstün performans ile cephelerinizde fark yaratıyoruz.



YÜKSEK DAYANIM

Güçlü alüminyum profiller ile uzun ömürlü kullanım



ISI YALITIMI

Enerji tasarrufu sağlayan üstün yalıtım performansı



SES YALITIMI

Dış ortam gürültüsünü minimuma indirir



SU VE HAVA YALITIMI

Zorlu hava koşullarına karşı maksimum koruma sağlar



ESTETİK TASARIM

Modern görünüm, geniş renk ve kaplama seçenekleri



GÜNEŞTEN KORUN
Maksimum konfor



RÜZGAR DİRENCİ
Yüksek dayanım



GÜVENLİK
Sağlam ve güvenli yapı



ÇEVRE DOSTU
Sürdürülebilir sistemler



TİCARİ YAPILAR



KONUT PROJELERİ



OFİS BİNALARI



KURUMSAL YAPILAR

27-101300

50'lik Cephe Profili / 50 Faced Profile
1.400 kg/m

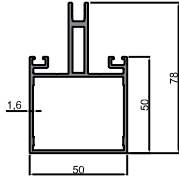

27-101301

80'lik Cephe Profili / 80 Faced Profile
1.660 kg/m

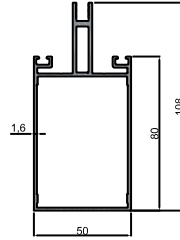

27-101303

100'lük Cephe Profili / 100 Faced Profile
1.844 kg/m

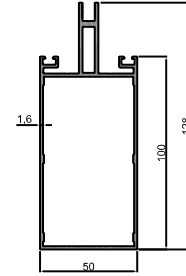

27-101302

120'lik Cephe Profili / 120 Faced Profile
2.168 kg/m

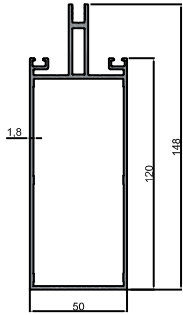

27-101305

Tijli Kaset Profili / Rod Frame Profile
0.723 kg/m

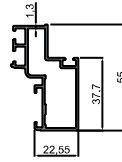

27-101304

Kaset Profili / Frame Profile
0.691 kg/m

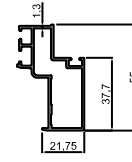

27-101307

Baskı Profili / Press Profile
0.386 kg/m

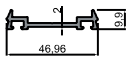

27-101306

Baskı Kapak Profili / Press Cup Profile
0.339 kg/m

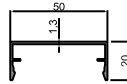

27-101308

Bağlantı Profili / Connection Profile
1.535 kg/m

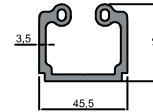

27-101309

Çıta Profili / Strip Profile
0.111 kg/m

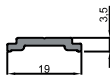

27-101310

Klips Profili / Clip Profile
0.260 kg/m

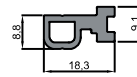



SMART
— CAM BALKON —
ALÜMİNYUM SİSTEMLERİ

SİGMA PROFİLLERİ

GÜÇ, DAYANIM VE ESTETİĞİN
MÜKEMMEL BİRLEŞİMİ

Yüksek kaliteli alüminyum hammaddeden
üretilen sigma profillerimiz, uzun ömürlü,
dayanıklı ve çok yönlü kullanım imkanı sağlar.



YÜKSEK DAYANIM

Güçlü et kalınlığı ile
maksimum taşıma kapasitesi



HASSAS ÖLÇÜ

Milimetrik üretim toleransı ile
mükemmel uyum



KOROZYON DİRENCİ

Eloksal ve elektrostatik kaplama ile
uzun ömürlü kullanım



KOLAY İŞLENEBİLİR

Kesim, delme ve montajda
pratik çözümler



KALİTELİ YÜZEY

Pürüzsüz yüzey kalitesi ile
estetik görünüm

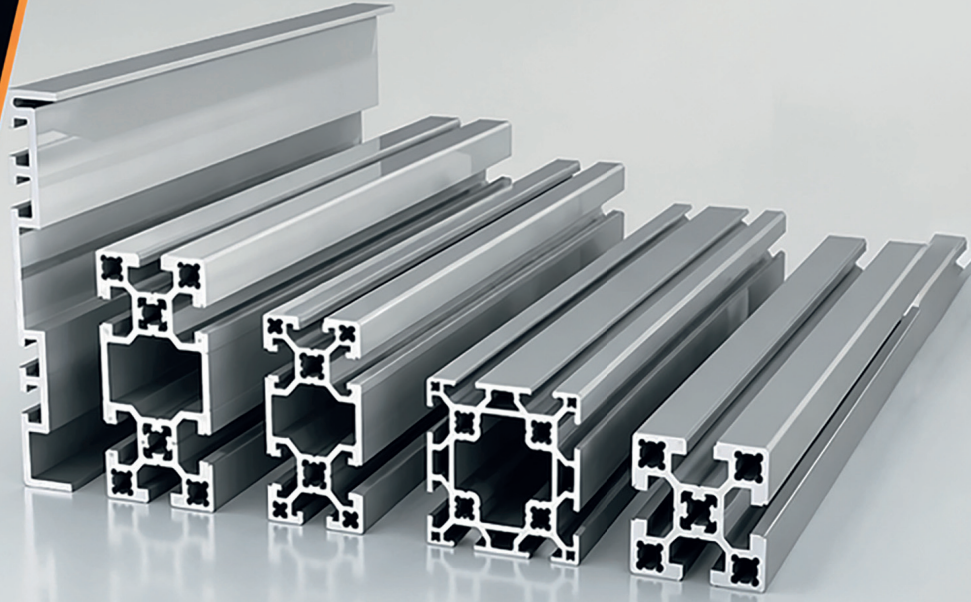

FARKLI ÖLÇÜ
SEÇENEKLERİ



YÜKSEK KALİTELİ
ALÜMİNYUM



ELEKTROSTATİK
TOZ BOYA



ZAMANINDA
TESLİMAT



smarcambalkon.com



0534 292 62 22



Ovacık Mah. 2034. Sok. No:6B
Alüminyumcular Sitesi KEÇİÖREN/ANKARA

KALİTE
GÜVEN
ÇÖZÜM

Sigma Profilleri / Sigma Profiles

31-10374

30x30 Sigma Profili / 30x30 Sigma Profile
0.989 kg/m

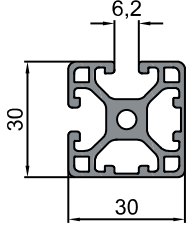

31-10366

40x40 Sigma Profili / 40x40 Sigma Profile
1.297 kg/m

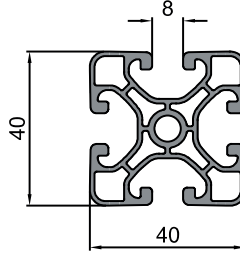

31-10368

80x40 Sigma Profili / 80x40 Sigma Profile
3.175 kg/m

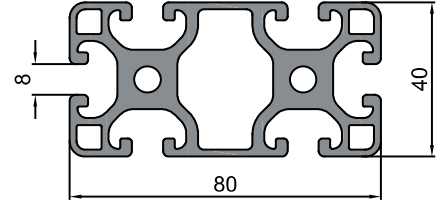

31-10375

80x40 Sigma Profili / 80x40 Sigma Profile
3.239 kg/m

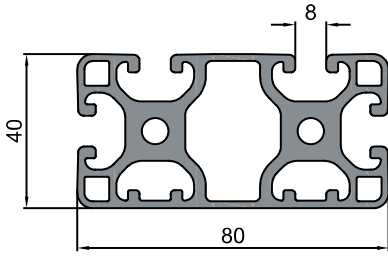

31-10367

80x80 Sigma Profili / 80x80 Sigma Profile
5.387 kg/m

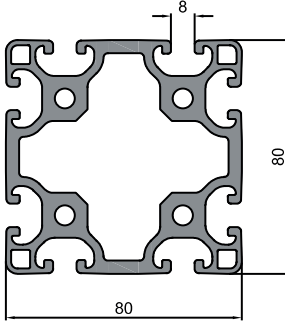

31-10373

40x10 Sigma Profili / 40x10 Sigma Profile
0.651 kg/m

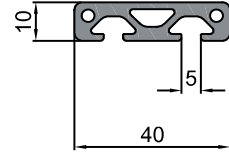



SMART
— CAM BALKON —
ALÜMİNYUM SİSTEMLERİ

GELECEĞİN ENERJİSİ YAŞAM ALANLARINDA SOLAR SİSTEMLER

Enerji üretirken konfor sağlayan
akıllı ve sürdürülebilir çözümler



ENERJİ ÜRETİMİ
Güneşten maksimum
verim



ESTETİK TASARIM
Mimariye uyumlu
modern sistem



DAYANIKLI YAPI
Alüminyum taşıyıcı
sistem ile uzun ömür



AKILLI ENTEGRASYON
Otomasyon ve akıllı ev
sistemleri ile uyumlu



TEMİZ ENERJİ
Çevre dostu
sürdürülebilir çözüm



YÜKSEK VERİM
Maksimum enerji
üretimi



GÜVENLİ SİSTEM
Yüksek güvenlik ve
dayanıklılık



EKONOMİK
Düşük enerji maliyeti
uzun vadeli kazanç



KONUT



TİCARİ



TERAS



CEPHE



GÜNEŞTEN
GÜCÜNÜ ALIR



ENERJİYE
DÖNÜŞTÜRÜR



YAŞAM ALANLARINIZA
DEĞER KATAR



DOĞAYA KATKI
GELECEĞE YATIRIM



smartcambalkon.com



0534 292 62 22



Ovacık Mah. 2034. Sok. No:6B
Alüminyumcular Sitesi KEÇİÖREN/ANKARA

KALİTE
GÜVEN
ÇÖZÜM

35-5312
Solar Enerji Ray Profili /
Solar Energy Rail Profile
2.200 kg/m

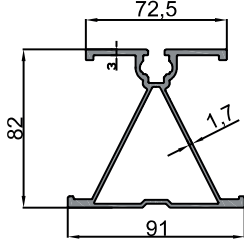

35-5359
Solar Enerji Ray Profili /
Solar Energy Rail Profile
1.309 kg/m

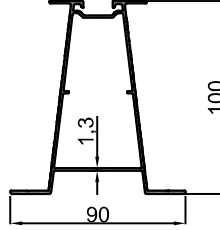

35-5303
Solar Enerji Ray Profili /
Solar Energy Rail Profile
0.810 kg/m

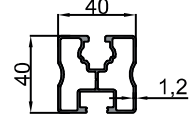

35-5360
Solar Enerji Bağlantı Profili /
Solar Energy Connection Profile
0.614 kg/m

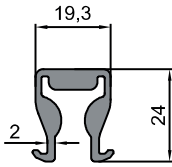

35-5309
Solar Enerji Orta Bağlantı Profili /
Solar Energy Middle Connection Profile
0.743 kg/m

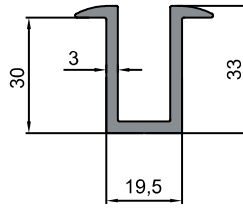

35-5361
Solar Enerji Orta Bağlantı Profili /
Solar Energy Middle Connection Profile
0.576 kg/m

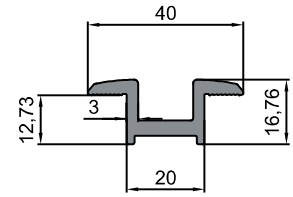

35-5362
Solar Enerji Bitiş Profili /
Solar Energy End Profile
0.770 kg/m

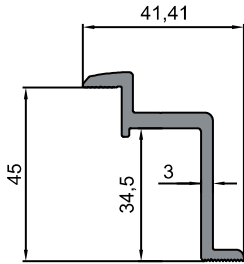

35-5363
Solar Enerji Bitiş Profili/
Solar Energy End Profile
0.725 kg/m

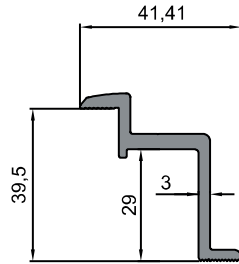

35-5310
Solar Enerji Bitiş Profili/
Solar Energy End Profile
0.494 kg/m

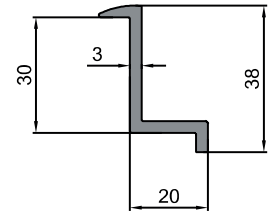

35-5311
Solar Enerji Bitiş Profili/
Solar Energy End Profile
0.535 kg/m

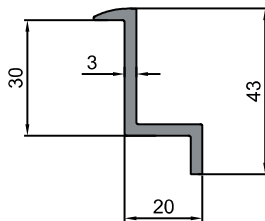

35-5368
Kiremit Çatı Ray Profili/Tile Roof Rail Profile
2.174 kg/m

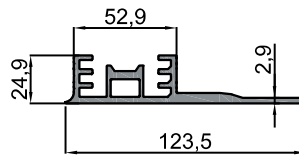

35-5367
Kiremit Çatı Kelepçe Profili/
Tile Roof Clamp Profile
0.760 kg/m

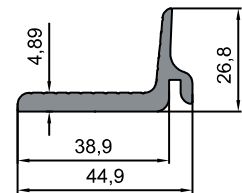

35-5382
Kiremit Çatı Panel Bağlantı Profili /
Tile Roof Panel Connection Profile
0.710 kg/m

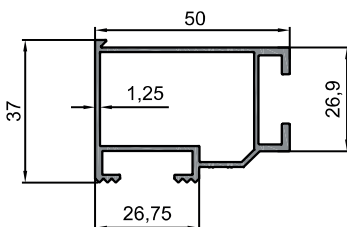

35-5383
Kiremit Çatı Panel Bağlantı Profili /
Tile Roof Panel Connection Profile
0.956 kg/m

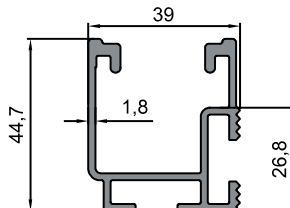

35-5385
Kiremit Çatı Panel Bağlantı Profili/
Tile Roof Panel Connection Profile
0.767 kg/m

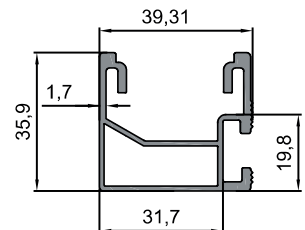

35-5384
Kiremit Çatı Bağlantı Profili/
Tile Roof Connection Profile
1.084 kg/m

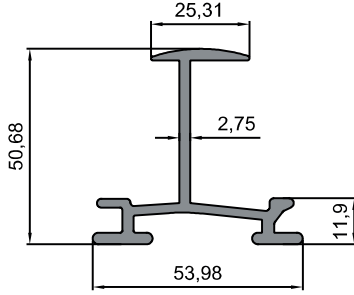

35-5365
Kiremit Çatı Üst Kasa Profili/
Tile Roof Top Frame Profile
3.131 kg/m

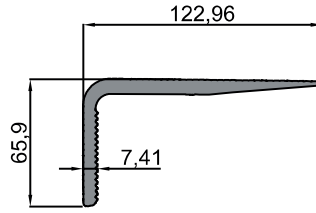

35-5366
Kiremit Çatı Alt Kasa Profili /
Tile Roof Bottom Frame Profile
5.041 kg/m

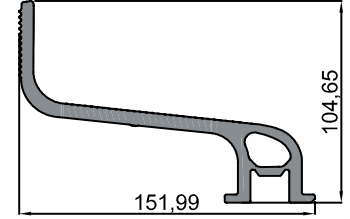

35-5364
Kiremit Çatı İç Bağlantı Profili/
Tile Roof Internal Connection Profile
0.625 kg/m

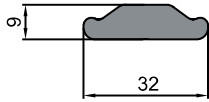

35-5355
Kiremit Çatı Kancası Profili/
Tile Roof Hook Profile
1.078 kg/m

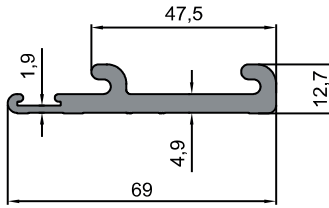



SMART
— CAM BALKON —
ALÜMİNYUM SİSTEMLERİ

STANDART ALÜMİNYUM PROFİLLERİ

HER SEKTÖR İÇİN
KALİTELİ VE GÜVENİLİR ÇÖZÜMLER

Geniş ürün yelpazemizle farklı sektörlerin ihtiyaçlarına uygun, dayanıklı ve uzun ömürlü alüminyum profilleri.



GENİŞ ÜRÜN YELPAZESİ
Farklı ölçü ve kesit seçenekleri ile ihtiyaca uygun çözümler



YÜKSEK DAYANIM
Korozyona karşı dirençli, uzun ömürlü kullanım



HASSAS ÖLÇÜ
Milimetrik üretim toleransı ile mükemmel uyum



KOLAY İŞLENEBİLİR
Kesim, delme ve montajda pratik çözümler

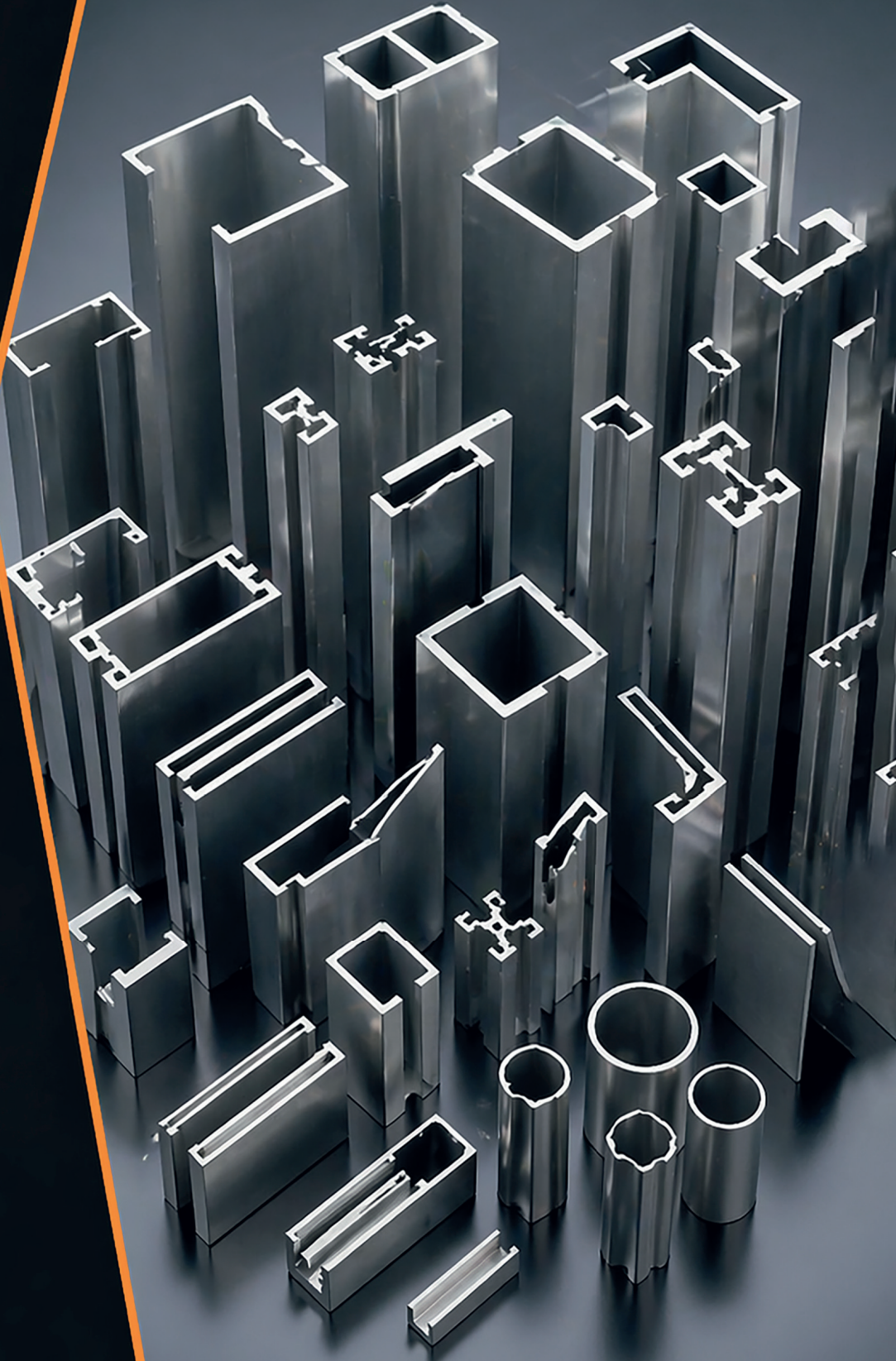

FARKLI ÖLÇÜ
SEÇENEKLERİ



YÜKSEK KALİTELİ
ALÜMİNYUM



STANDARTLARA UYGUN
ÜRETİM



ZAMANINDA
TESLİMAT



smarcambalkon.com



0534 292 62 22



Ovacık Mah. 2034. Sok. No:6B
Alüminyumcular Sitesi KEÇİÖREN/ANKARA

KALİTE
GÜVEN
ÇÖZÜM

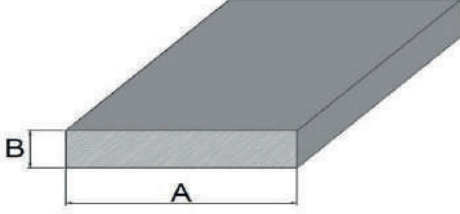

No	Kalıp Kodu (Mold No)	Profil Ölçüler (Profile Dimensions)		Ağırlık (Weight) (kg/m)
		A (mm)	B (mm)	
1	1630	20	2	0.108
2	1388	20	3	0.163
3	1631	20	4	0.217
4	1270	20	5	0.271
5	1632	20	8	0.434
6	1389	20	10	0.542
7	1633	20	15	0.813
8	1593	25	3	0.203
9	1390	25	5	0.339
10	1634	25	8	0.542
11	1635	25	15	1.016
12	1405	30	2	0.163
13	1392	30	3	0.244
14	1636	30	4	0.325
15	1393	30	5	0.406
16	1637	30	6	0.488
17	1394	30	8	0.651
18	1395	30	10	0.813
19	1594	30	12	0.976
20	1275	30	15	1.220
21	1276	30	20	1.626
22	1638	35	20	1.897
23	1407	40	2	0.217
24	1266	40	3	0.325
25	1396	40	4	0.434
26	1397	40	5	0.542
27	1255	40	6	0.655
28	1398	40	8	0.867
29	1399	40	10	1.084
30	1639	40	12	1.301
31	1409	40	15	1.626
32	1410	40	20	2.169
33	1640	40	25	2.710
34	1641	40	30	3.252
35	1408	50	2	0.271
36	1114	50	3	0.406
37	1411	50	4	0.542
38	1412	50	5	0.678
39	1413	50	6	0.813

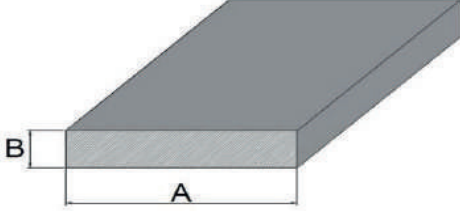

No	Kalıp Kodu (Mold No)	Profil Ölçüler (Profile Dimensions)		Ağırlık (Weight) (kg/m)
		A (mm)	B (mm)	
40	1414	50	8	1.084
41	1415	50	10	1.355
42	1655	50	12	1.626
43	1416	50	15	2.033
44	1417	50	20	2.711
45	1656	50	25	3.388
46	1657	50	30	4.065
47	1658	50	40	5.420
48	1588	60	2	0.325
49	1118	60	3	0.488
50	1419	60	4	0.650
51	1191	60	5	0.813
52	1420	60	6	0.976
53	1421	60	8	1.301
54	1256	60	10	1.630
55	1254	60	12	1.955
56	1422	60	15	2.439
57	1423	60	20	3.252
58	1659	60	25	4.065
59	1660	60	30	4.878
60	1277	60	40	6.504
61	1683	70	3	0.570
62	1598	70	4	0.759
63	1265	70	5	0.948
64	1627	70	6	1.138
65	1264	70	8	1.518
66	1289	70	10	1.897
67	1253	70	12	2.280
68	1723	70	15	2.846
69	1661	70	20	3.794
70	1662	70	25	4.742
71	1663	70	30	5.691
72	1664	70	40	7.588
73	1251	80	2	0.434
74	1665	80	3	0.650
75	1666	80	4	0.867
76	1263	80	5	1.084
77	1667	80	6	1.301

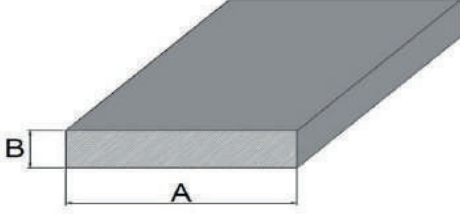

No	Kalıp Kodu (Mold No)	Profil Ölçüler (Profile Dimensions)		Ağırlık (Weight) (kg/m)
		A (mm)	B (mm)	
78	1262	80	8	1.734
79	1261	80	10	2.168
80	1252	80	12	2.605
81	1432	80	15	3.252
82	1433	80	20	4.336
83	1668	80	25	5.420
84	1669	80	30	6.504
85	1300	80	40	8.672
86	1731	90	16	3.902
87	1670	100	3	0.813
88	1671	100	4	1.084
89	1192	100	5	1.355
90	1301	100	6	1.626
91	1434	100	8	2.168
92	1193	100	10	2.711
93	1672	100	12	3.252
94	1435	100	15	4.065
95	1436	100	20	5.420
96	1673	100	25	6.775
97	1674	100	30	8.130
98	1675	100	40	10.840
99	1437	120	5	1.626
100	1676	120	8	2.602
101	1438	120	10	3.252
102	1677	120	15	4.878
103	1439	120	20	6.504
104	1728	140	15	5.693
105	1440	150	5	2.033
106	1678	150	8	3.252
107	1441	150	10	4.065
108	1679	150	12	4.878
109	1302	150	15	6.098
110	1680	150	20	8.130
111	1303	200	5	2.710
112	1681	200	8	4.336
113	1442	200	10	5.420
114	1682	200	15	8.130
115	1443	250	10	6.775
116	1728	140	15	5.693

Lama Profilleri / Flat Bar Profiles

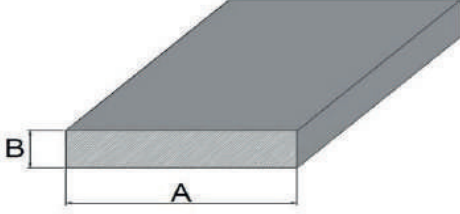

No	Kalıp Kodu (Mold No)	Profil Ölçüler (Profile Dimensions)		Ağırlık (Weight) (kg/m)
		A (mm)	B (mm)	
117	1683	70	3	0.570
118	1723	70	15	2.846

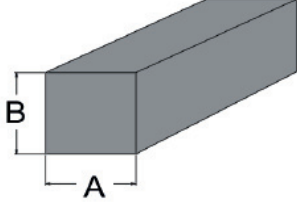

No	Kalıp Kodu (Mold No)	Profil Ölçüler (Profile Dimensions)		Ağırlık (Weight) (kg/m)
		A (mm)	A (mm)	
1	1701	8	8	0.173
2	1386	10	10	0.271
3	1387	15	15	0.610
4	1188	20	20	1.084
5	1391	25	25	1.694
6	1189	30	30	2.440
7	1190	40	40	4.338
8	1418	50	50	6.775
9	1424	60	60	9.756

İkizkenar Köşebent Profilleri / Isosceles Angle Profiles

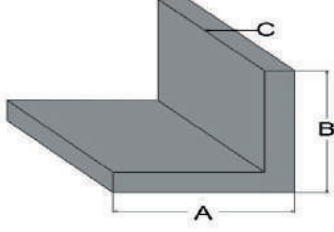

No	Kalıp Kodu (Mold No)	Profil Ölçüler (Profile Dimensions)			Ağırlık (Weight) (kg/m)
		A (mm)	B (mm)	C (mm)	
1	1702	10	10	2	0.098
2	1194	15	15	2	0.152
3	2052	20	20	1.2	0.130
4	1332	20	20	2	0.206
5	1333	20	20	3	0.301
6	1334	25	25	2	0.260
7	1335	25	25	3	0.382
8	1703	25	25	4	0.499
9	1148	30	30	2	0.314
10	1336	30	30	3	0.464
11	1195	30	30	4	0.607
12	1600	30	30	5	0.745
13	1196	35	35	2	0.369
14	1601	35	35	3	0.545
15	1150	40	40	2	0.423
16	1337	40	40	3	0.626
17	1338	40	40	4	0.824
18	1339	40	40	5	1.017
19	1340	45	45	2	0.477
20	1704	45	45	5	1.152
21	1341	50	50	2	0.531
22	1197	50	50	3	0.789
23	1342	50	50	4	1.041
24	1343	50	50	5	1.288
25	1603	50	50	6	1.528
26	1604	50	50	8	1.995
27	1705	50	50	10	2.439
28	1344	60	60	2	0.640
29	1345	60	60	3	0.951
30	1346	60	60	4	1.257
31	1347	60	60	5	1.558
32	1348	60	60	6	1.854
33	1605	60	60	8	2.428
34	1606	60	60	10	2.981
35	1278	80	80	3	1.276
36	1198	80	80	5	2.101
37	1199	80	80	8	3.296
38	1706	80	80	10	4.065

İkizkenar Köşebent Profilleri / Isosceles Angle Profiles

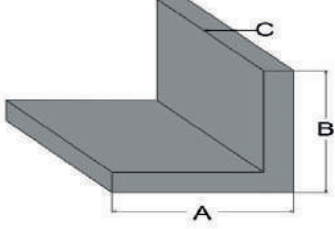

No	Kalıp Kodu (Mold No)	Profil Ölçüler (Profile Dimensions)			Ağırlık (Weight) (kg/m)
		A (mm)	B (mm)	C (mm)	
39	1707	90	90	10	4.607
40	1349	100	100	10	5.151
41	1283	100	100	3	1.602
42	1284	100	100	4	2.125
43	1285	100	100	5	2.642
44	1286	100	100	6	3.154
45	1287	100	100	8	4.163

Kenarları Eşit Olmayan Köşebent Profilleri /
Unequal Angle Profiles

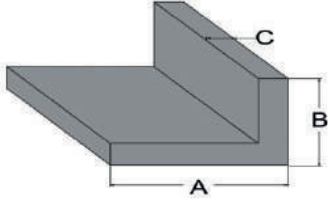

No	Kalıp Kodu (Mold No)	Profil Ölçüler (Profile Dimensions)			Ağırlık (Weight) (kg/m)
		A (mm)	B (mm)	C (mm)	
1	1591	20	10	2	0.152
2	1590	20	15	2	0.179
3	1607	25	20	2	0.233
4	1592	30	10	2	0.206
5	1200	30	15	2	0.233
6	1142	30	20	2	0.260
7	1351	30	20	3	0.382
8	1143	40	10	2	0.260
9	2055	40	20	1.1	0.180
10	122	40	20	2	0.315
11	1352	40	20	3	0.463
12	1353	40	30	2	0.369
13	1354	40	30	3	0.545
14	1267	50	20	2	0.369
15	1608	50	20	3	0.545
16	1202	50	30	2	0.423
17	1355	50	30	3	0.626
18	1356	50	30	5	1.016
19	1357	60	20	2	0.423
20	1613	60	20	3	0.626
21	1359	60	30	2	0.477
22	1360	60	30	3	0.707
23	1361	60	40	2	0.531
24	1362	60	40	3	0.789
25	1363	60	40	4	1.041
26	1364	60	40	5	1.287
27	1269	70	20	2	0.477
28	1365	80	20	2	0.531
29	1203	80	30	3	0.870
30	1366	80	40	2	0.650
31	1367	80	40	3	0.951
32	1368	80	40	4	1.257
33	1304	80	40	5	1.558
34	1369	80	40	6	1.854
35	1734	80	50	3	1.032
36	1370	80	50	5	1.694
37	1371	100	20	2	0.640

Kenarları Eşit Olmayan Köşebent Profilleri /
Unequal Angle Profiles

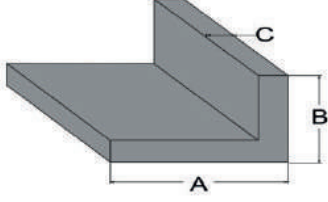

No	Kalıp Kodu (Mold No)	Profil Ölçüler (Profile Dimensions)			Ağırlık (Weight) (kg/m)
		A (mm)	B (mm)	C (mm)	
38	1614	100	30	3	1.033
39	1615	100	40	3	1.114
40	1616	100	40	4	1.474
41	1204	100	50	3	1.195
42	1372	100	50	5	1.965
43	1373	100	50	6	2.341
44	1617	100	50	8	3.079
45	1374	100	50	10	3.795
46	1375	100	60	6	2.504
47	1376	120	50	5	2.236
48	1377	120	60	6	2.829
49	1378	120	60	8	3.729
50	1379	120	80	8	4.163
51	1380	120	80	10	5.149
52	1618	130	30	3	1.276
53	1381	150	50	4	2.125
54	1619	150	50	5	2.642
55	1383	150	75	8	4.706
56	1305	150	100	5	3.320
57	1384	150	100	10	6.506
58	1735	160	50	3	1.683
59	1385	200	100	10	7.859

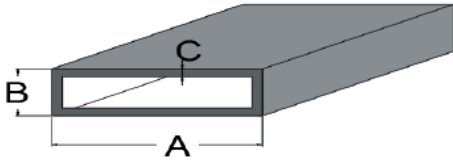

No	Kalıp Kodu (Mold No)	Profil Ölçüler (Profile Dimensions)			Ağırlık (Weight) (kg/m)
		A (mm)	B (mm)	C (mm)	
1	1281	25	15	2	0.390
2	1554	30	10	2	0.390
3	1555	30	15	2	0.445
4	1464	30	20	2	0.499
5	1400	30	25	2	0.553
6	1556	40	15	2	0.553
7	1645	40	20	1.3	0.403
8	1729	40	20	1.5	0.463
9	1465	40	20	2	0.607
10	1466	40	20	3	0.878
11	1559	40	25	2	0.661
12	1467	40	30	2	0.716
13	1560	40	30	3	1.041
14	1215	50	15	2	0.661
15	1216	50	25	2	0.770
16	1561	50	25	3	1.122
17	1166	50	20	2	0.716
18	1282	50	20	3	1.041
19	1646	50	30	2	0.824
20	1468	50	30	3	1.204
21	1309	50	40	2	0.932
22	1566	50	40	3	1.366
23	1469	60	20	2	0.824
24	1217	60	20	3	1.204
25	1470	60	30	2	0.933
26	1471	60	30	3	1.366
27	1609	60	40	1.5	0.789
28	1649	60	40	2	1.041
29	1472	60	40	3	1.529
30	1473	60	40	4	1.995
31	1310	60	50	3	1.691
32	1218	70	20	2	0.933
33	1567	70	40	3	1.691
34	1474	80	20	2	1.041
35	1126	80	30	2	1.149
36	1562	80	30	3	1.691
37	1602	80	40	1.6	1.013
38	1475	80	40	2	1.258

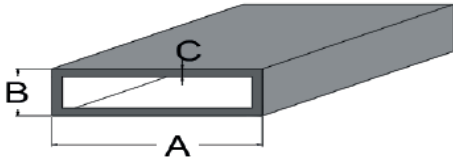

No	Kalıp Kodu (Mold No)	Profil Ölçüler (Profile Dimensions)			Ağırlık (Weight) (kg/m)
		A (mm)	B (mm)	C (mm)	
39	1476	80	40	3	1.854
40	1477	80	40	4	2.429
41	1572	80	50	2	1.366
42	1573	80	50	3	2.016
43	1574	80	50	4	2.645
44	1478	80	60	3	2.180
45	1479	80	60	4	2.863
46	1480	100	20	2	1.258
47	1219	100	25	2	1.312
48	1564	100	30	2	1.366
49	1563	100	30	3	2,016
50	1568	100	40	2	1.475
51	1220	100	40	3	2.180
52	1569	100	40	4	2.863
53	1481	100	50	2	1.583
54	1482	100	50	3	2.342
55	1483	100	50	4	3.080
56	1484	100	50	5	3.795
57	1576	100	60	3	2.505
58	1577	100	60	4	3.297
59	1579	100	80	3	2.829
60	1580	100	80	4	3.729
61	1485	120	20	2	1.475
62	1565	120	30	2	1.583
63	1586	120	30	3	2.342
64	1570	120	40	2	1.691
65	1571	120	40	4	3.297
66	1221	120	50	3	2.668
67	1222	120	50	4	3.514
68	1486	120	60	3	2.830
69	1487	120	60	4	3.730
70	1223	120	80	3	3.156
71	1581	120	80	4	4.164
72	1311	140	40	4	3.729
73	1578	140	60	4	4.163
74	1224	140	80	4	4.598
75	1557	150	20	2	1.799

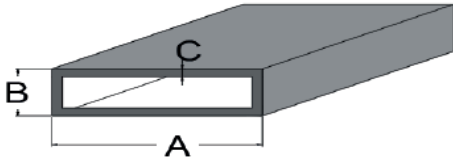

No	Kalıp Kodu (Mold No)	Profil Ölçüler (Profile Dimensions)			Ağırlık (Weight) (kg/m)
		A (mm)	B (mm)	C (mm)	
76	1587	150	40	4	3.947
77	1488	150	50	2	2.125
78	1225	150	50	3	3.156
79	1489	150	50	4	4.164
80	1312	150	50	5	5.149
81	1582	150	80	4	4.813
82	1490	150	100	3	3.969
83	1491	150	100	4	5.247
84	1492	160	80	4	5.032
85	1313	180	40	4	4.596
86	1724	180	60	4	5.032
87	1314	180	80	4	5.463
88	1725	200	40	3	3.806
89	1493	200	50	4	5.247
90	1583	200	80	4	5.897
91	1494	200	100	4	6.331

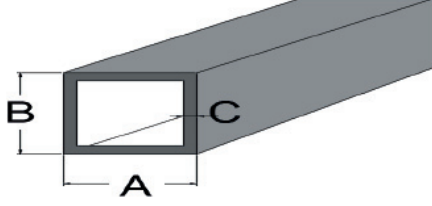

No	Kalıp Kodu (Mold No)	Profil Ölçüler (Profile Dimensions)			Ağırlık (Weight) (kg/m)
		A (mm)	B (mm)	C (mm)	
1	1722	15	15	1	0.152
2	1535	15	15	1.5	0.220
3	1536	15	15	2	0.282
4	1163	20	20	1.5	0.301
5	1444	20	20	2	0.390
6	1308	20	20	3	0.553
7	1537	25	25	1.5	0.382
8	1445	25	25	2	0.499
9	1538	25	25	3	0.715
10	2065	30	30	1.5	0.465
11	1446	30	30	2	0.607
12	1447	30	30	3	0.878
13	1539	30	30	4	1.127
14	1448	35	35	2	0.716
15	1540	35	35	3	1.041
16	1644	40	40	1.3	0.545
17	1165	40	40	2	0.824
18	1449	40	40	3	1.204
19	1450	40	40	4	1.562
20	1542	40	40	5	1.898
21	1543	45	45	2	0.933
22	1648	50	50	2	1.041
23	1212	50	50	3	1.529
24	1451	50	50	4	1.995
25	1452	50	50	5	2.439
26	1453	60	60	2	1.257
27	1454	60	60	3	1.854
28	1455	60	60	4	2.429
29	1544	60	60	5	2.981
30	1545	70	70	2	1.474
31	1546	70	70	3	2.179
32	1456	70	70	4	2.863
33	1547	80	80	2	1.691
34	1457	80	80	3	2.504
35	1213	80	80	4	3.296
36	1548	80	80	5	4.067
37	1549	80	80	6	4.813
38	1280	90	90	4	3.729

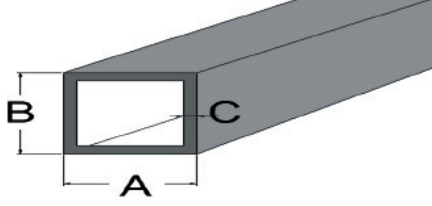

No	Kalıp Kodu (Mold No)	Profil Ölçüler (Profile Dimensions)			Ağırlık (Weight) (kg/m)
		A (mm)	B (mm)	C (mm)	
39	1595	99	99	2	2.103
40	1214	100	100	2	2.125
41	1458	100	100	3	3.156
42	1459	100	100	4	4.164
43	1460	100	100	5	5.149
44	1550	100	100	10	9.756
45	1551	120	120	2.5	3.184
46	1461	120	120	4	5.032
47	1552	120	120	5	6.233
48	1754	150	150	2	3.210
49	1462	150	150	3	4.782
50	1463	150	150	5	7.859

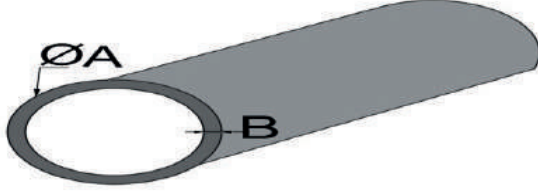

No	Kalıp Kodu (Mold No)	Profil Ölçüler (Profile Dimensions)		Ağırlık (Weight) (kg/m)
		Q A(mm)	B (mm)	
1	1708	15	2	0.221
2	2760	16	2	0.238
3	1201	20	2	0.307
4	1710	20	3	0.434
5	1208	25	1.5	0.300
6	1207	25	2	0.392
7	1226	25	3	0.562
8	1227	30	1.5	0.364
9	2759	30	2	0.477
10	1228	30	3	0.690
11	1229	30	4	0.885
12	1230	30	5	1.064
13	1209	32	2	0.511
14	2758	35	2	0.565
15	1231	35	3	0.818
16	1712	35	4	1.056
17	1713	35	5	1.277
18	1306	38	2	0.613
19	1714	40	1.5	0.492
20	2756	40	2	0.650
21	1232	40	3	0.945
22	1233	40	4	1.226
23	1234	40	5	1.490
24	1715	40	10	2.554
25	1783	42	2	0.681
26	1210	42	3	0.996
27	1767	44.5	8.75	2.670
28	1235	45	2	0.732
29	1307	48	2	0.783
30	1236	48	3	1.150
31	1237	48	4	1.498
32	2751	50	1.5	0.620
33	2761	50	2	0.818
34	1238	50	3	1.201
35	1239	50	4	1.567
36	1240	50	5	1.916
37	1241	60	2	0.988
38	1242	60	3	1.456
39	1243	60	4	1.907

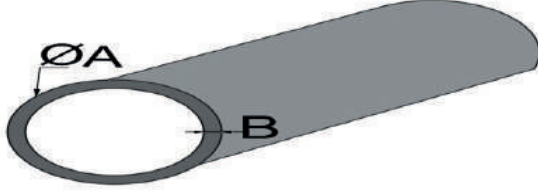

No	Kalıp Kodu (Mold No)	Profil Ölçüler (Profile Dimensions)		Ağırlık (Weight) (kg/m)
		Q A(mm)	B (mm)	
40	1244	60	5	2.342
41	1533	60	10	4.259
42	1732	60	11.25	4.669
43	1736	60	11.40	4.719
44	1757	60.5	11.65	4.845
45	1245	65	2	1.073
46	1716	70	2	1.158
47	1246	70	3	1.711
48	1247	70	5	2.767
49	1717	75	5	2.98
50	1248	80	2	1.328
51	1249	80	3	1.967
52	1317	80	5	3.194
53	1318	90	5	3.618
54	1319	100	2	1.669
55	1211	100	3	2.478
56	1718	100	4	3.269
57	1320	100	5	4.045
58	1534	100	10	7.662
59	1719	110	5	4.470
60	1730	110	10	8.514
61	1720	120	3	2.988
62	1322	120	5	4.895
63	1721	140	5	5.747
64	1324	150	3	3.755
65	1325	150	5	6.172

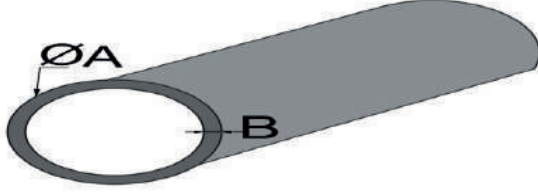

No	Kalıp Kodu (Mold No)	Profil Ölçüler (Profile Dimensions)		Ağırlık (Weight) (kg/m)
		Q A(mm)	B (mm)	
40	1244	60	5	2.342
41	1533	60	10	4.259
42	1732	60	11.25	4.669
43	1736	60	11.40	4.719
44	1757	60.5	11.65	4.845
45	1245	65	2	1.073
46	1716	70	2	1.158
47	1246	70	3	1.711
48	1247	70	5	2.767
49	1717	75	5	2.98
50	1248	80	2	1.328
51	1249	80	3	1.967
52	1317	80	5	3.194
53	1318	90	5	3.618
54	1319	100	2	1.669
55	1211	100	3	2.478
56	1718	100	4	3.269
57	1320	100	5	4.045
58	1534	100	10	7.662
59	1719	110	5	4.470
60	1730	110	10	8.514
61	1720	120	3	2.988
62	1322	120	5	4.895
63	1721	140	5	5.747
64	1324	150	3	3.755
65	1325	150	5	6.172



SMART
= ALUMINYUM =

U Profiller / U Profiles

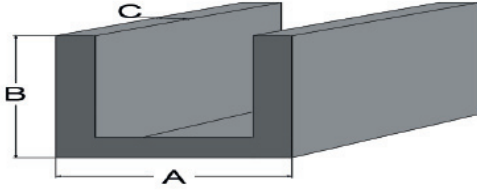

No	Kalıp Kodu (Mold No)	Profil Ölçüler (Profile Dimensions)			Ağırlık (Weight) (kg/m)
		A (mm)	B (mm)	C (mm)	
1	1501	15	15	2	0.222
2	1502	20	20	2	0.304
3	1503	30	20	2	0.412
4	1504	40	20	2	0.521
5	1589	23	23	1.5	0.268
6	1505	25	25	2	0.385
7	1506	25	25	3	0.561
8	1507	20	30	2	0.358
9	1508	30	30	2	0.466
10	1260	30	30	3	0.683
11	1509	35	35	2	0.547
12	1510	35	35	3	0.805
13	1511	20	40	2	0.412
14	1620	20	40	3	0.602
15	1512	30	40	3	0.764
16	1100	40	40	2	0.630
17	1513	40	40	3	0.927
18	1514	40	40	4	1.214
19	1515	20	50	2	0.466
20	1516	30	50	3	0.846
21	1517	30	50	4	1.106
22	1518	40	50	4	1.322
23	1519	50	50	3	1.171
24	1520	50	50	4	1.539
25	1521	50	50	5	1.897
26	1522	30	60	3	0.927
27	1523	40	60	3	1.089
28	1524	40	60	4	1.431
29	1525	40	60	5	1.762
30	1526	60	60	3	1.415
31	1527	60	60	4	1.864
32	1528	60	60	5	2.304
33	1529	30	80	3	1.089
34	1530	40	80	3	1.252
35	1531	40	80	4	1.648
36	1404	40	80	5	2.033
37	1532	50	80	5	2.304
38	1621	40	100	3	1.415
39	1622	50	100	3	1.577
40	1205	50	100	5	2.575

U Profiller / U Profiles

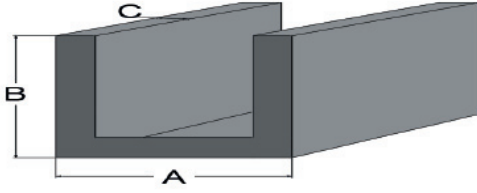

No	Kalıp Kodu (Mold No)	Profil Ölçüler (Profile Dimensions)			Ağırlık (Weight) (kg/m)
		A (mm)	B (mm)	C (mm)	
41	1279	55	65	2.5	1.152
42	1597	60	112	4	2.862
43	1726	60	140	7	4.668

T Profiller / T Profiles

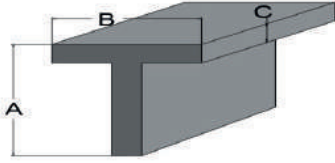

No	Kalıp Kodu (Mold No)	Profil Ölçüler (Profile Dimensions)			Ağırlık (Weight) (kg/m)
		A (mm)	B (mm)	C (mm)	
1	1623	30	30	2	0.325
2	1624	30	30	3	0.463
3	1625	35	35	3	0.545
4	1206	40	40	3	0.626
5	1495	40	40	4	0.824
6	1497	50	50	5	1.287
7	1626	60	60	4	1.257

FABRİKA ÜRETİM KONTROLÜ
Uygunluk Belgesi
Belge No: 2163-CPR-1513

Avrupa Parlamentosu ve Konseyi'nin 9 Mart 2011 tarih ve 305/2011/EU sayılı Tüzüğü (Yapı Malzemeleri Tüzüğü CPR) uyarınca, bu belge aşağıda belirtilen yapı malzemelerini kapsar.

SMART ALÜMİNYUM İNŞAAT MÜHENDİSLİK MÜŞAVİRLİK
SANAYİ VE TİCARET LIMITED ŞİRKETİ

firması tarafından
Ovacık Mahallesi 2034. Sokak No:6B Alüminyumcular Sitesi KEÇİÖREN/ANKARA
Adresindeki fabrikasında üretilen ve pazara sürülen

ALÜMİNYUM ALAŞIMLARINDAN EXTRÜZE EDİLMİŞ

EN 755-1 e göre
Yuvarlak, kare,dikdörtgen ve altgen kesitli çubuklar
Dikışış borular(kare ve dikdörtgen dahil)
Lomboz Boruları Profiller
EN 12020-1 göre PROFİLLER
MAMUL KALİTESİ: EN AW 6060, EN AW 6063
(TEMPER DURUMU T6)

Tanımlı ürünler imalatçı tarafından başlangıç tip deneylerine tabi tutulmuş ve fabrika üretim kontrolü sağlanmıştır.

EN 15088:2005

Bu sertifika, sertifikada belirtilen ürün performansları için yukarıdaki standardın ZA Ekinde Sistem 2+ ya göre belirtilen performansın değişmezliği değerlendirme ve doğrulama (PDD) hükümlerinin sağlandığını ve üretici tarafından uygulanmakta olan fabrika üretim kontrol sisteminin yapı malzemesinin performansının değişmezliğini güvence altına almak üzere denetlenmiş belgeler. Bu belge, ilk olarak 13.10.2025 tarihinde düzenlenmiş olup, uyumlaştırılmış standart, Yapı Malzemesi, PDD yöntemleri ya da üretim tesisindeki imalat koşulları önemli ölçüde değiştirilmediği sürece, Onaylanmış Fabrika Üretim Kontrolü Belgeleme Kurulunu tarafından askıya alınmaz veya iptal edilmez ise 12/10/2026 tarihine kadar geçerlidir.

ISTANBUL – 13 /10/2025

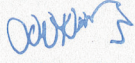

Suat KACMAZ
UNIVERSAL CERTIFICATION
Yönetim Kurulu Başkanı



UNIVERSALCERT.COM

FACTORY PRODUCTION CONTROL
Certificate Of Conformity
Certificate Number: 2163 - CPR – 1513

In compliance with Regulation 305/2011/EU of the European Parliament and of the Council of 9 March 2011 (the Construction Products Regulation, CPR), this certificate applies to the construction products produced by:

SMART ALÜMİNYUM İNŞAAT MÜHENDİSLİK MÜŞAVİRLİK
SANAYİ VE TİCARET LIMITED ŞİRKETİ

produced and introduced on the market in the factory
Ovacık Mahallesi 2034. Sokak No:6B Alüminyumcular Sitesi KEÇİÖREN/ANKARA

EXTRUDED FROM ALUMINUM ALLOYS

According to EN 755-1
Round, square, rectangular, and hexagonal cross-section bars
Seamless tubes (including square and rectangular)
Porthole Tubes Profiles
According to EN 12020-1 PROFILES
PRODUCT QUALITY: EN AW 6060, EN AW 6063
(TEMPER STATE T6)

The manufacturer submitted the defined products to initial type-testing and established a factory production control.

EN 15088:2005

This certificate, attests that all provisions concerning the assessment and verification of constancy of performance (AVCP) described in the Annex ZA of the above standard under System 2+ for the performances set out in this certificate are applied and that the factory production control, conducted by the manufacturer, is assessed to ensure constancy of performance of the construction product

This certificate is initially issued on 13.10.2025 and will remain valid until 12.10.2026 as long as neither the harmonised standard, the construction product, the AVCP methods nor the manufacturing conditions in the plant are modified significantly, unless suspended or withdrawn by the notified product certification body.

ISTANBUL – 13 /10/2025



Suat KACMAZ
UNIVERSAL CERTIFICATION
Çirman



UNIVERSALCERT.COM

CERTIFICATE
SERTİFİKA

SMART ALÜMİNYUM İNŞAAT MÜHENDİSLİK MÜŞAVİRLİK
SANAYİ VE TİCARET LIMITED ŞİRKETİ

Ovacık Mahallesi 2034. Sokak No:6B Alüminyumcular Sitesi KEÇİÖREN/ANKARA

ISO 9001:2015
Scope / Kapsam

 Alüminyum Bar, Çubuk, Tel, Profil, Tüp, Boru ve Bağlantı Parçaları İmalatı,
İthalatı ve İhracatı

Manufacturing, Import and Export of Aluminum Bars, Rods, Wires, Profiles, Tubes, Pipes and Fittings

This certificate certifies that the organization mentioned above meets the requirements of the stated standard.
Bu sertifika ile yukarıda adı geçen kuruluşun ve standardın gerekliliklerini karşıladığı tasdik olunur.

Certificate Number / Sertifika No: Q-250516-140-001

Date of Initial Reg. / İlk Kayıt Tarihi: 16.05.2025

Date of Certificate / Basım Tarihi: 16.05.2025

Date of Expiry / Geçerlilik Tarihi: 15.05.2026

Revision / Revizyon: 00

This certificate is valid until the end of the three-year certification period, provided that the organization complies with the certification body's requirements and successfully passes the annual surveillance audits conducted at least once a year.
Bu sertifika kuruluşun sertifikasyon şartlarına uyması ve yılda en az 1 kez yapılacak olan gözetim denetimlerinin başarılı geçmesi halinde üç yıllık sertifikasyon bizi tarihine kadar geçerlidir.



General Manager
Genel Müdür

DEVICERT INTERNATIONAL INSPECTION, CERTIFICATION AND TRAINING SERVICES DOO
HERCEGOVAČKA 50 PODGORICA info@devicert.com devicert.com

CERTIFICATE
SERTİFİKA

SMART ALÜMİNYUM İNŞAAT MÜHENDİSLİK MÜŞAVİRLİK
SANAYİ VE TİCARET LIMITED ŞİRKETİ

Ovacık Mahallesi,2034. Sokak No:6B Alüminyumcular Sitesi KEÇİÖREN/ANKARA

ISO 14001:2015
Scope / Kapsam

 Alüminyum Bar, Çubuk, Tel, Profil, Tüp, Boru ve Bağlantı Parçaları İmalatı,
İthalatı ve İhracatı

Manufacturing, Import and Export of Aluminum Bars, Rods, Wires, Profiles, Tubes, Pipes and Fittings

This certificate certifies that the organization mentioned above meets the requirements of the stated standard.
Bu sertifika ile yukarıda adı geçen kuruluşun ve standardın gerekliliklerini karşıladığı tasdik olunur.

Certificate Number / Sertifika No: E-250516-140-002

Date of Initial Reg. / İlk Kayıt Tarihi: 16.05.2025

Date of Certificate / Basım Tarihi: 16.05.2025

Date of Expiry / Geçerlilik Tarihi: 15.05.2026

Revision / Revizyon: 00

This certificate is valid until the end of the three-year certification period, provided that the organization complies with the certification body's requirements and successfully passes the annual surveillance audits conducted at least once a year.
Bu sertifika kuruluşun sertifikasyon şartlarına uyması ve yılda en az 1 kez yapılacak olan gözetim denetimlerinin başarılı geçmesi halinde üç yıllık sertifikasyon bizi tarihine kadar geçerlidir.



General Manager
Genel Müdür

DEVICERT INTERNATIONAL INSPECTION, CERTIFICATION AND TRAINING SERVICES DOO
HERCEGOVAČKA 50 PODGORICA info@devicert.com devicert.com

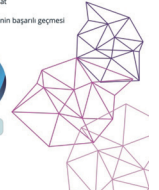

ArtPlus
CERTIFICATION

Certificate

ArtPlus, bu sertifika ile aşağıda bilgileri verilen kuruluşun ilgili standartın şartlarına uygun bir yönetim sistemi kurduğunu ve uyguladığını onaylar.

ArtPlus, approves that for the company with the following information has established and implemented the requirements of standard of management system.

**SMART ALÜMİNYUM İNŞAAT MÜHENDİSLİK MÜŞAVİRLİK
SANAYİ VE TİCARET LIMITED ŞİRKETİ**

Ovacık Mahallesi 2034. Sokak No:6B Alüminyumcular Sitesi KEÇİÖREN/ANKARA

ISO 10002:2018

MÜŞTERİ MEM. VE MÜŞTERİ ŞİKAYETLERİ Y.S.
CUSTOMER SATISFACTION AND CUSTOMER COMPLAINT M.S.

KAPSAM/SCOPE

ALÜMİNYUM PROFİL İMALATI VE SATIŞI, İTHALAT VE İHRACATI

ALUMINUM PROFILE MANUFACTURING AND SALES, IMPORT AND EXPORT

Sertifika No/Certificate No : C10012208

İlk Yayın Tarihi/First Issue Date : 16.05.2025
Geçerlilik Tarihi/Expiry Date : 16.05.2025

Yayın Tarihi/Issue Date : 16.05.2025
Bitiş Tarihi/End Date : 15.05.2026

ONAY

Bu sertifika, ArtPlus Certification'ın belgelendirmeye şartlarına uygun ve her yıl yapılacak olan denetimlerin başarılı bir şekilde tamamlanması durumunda, 30 ayın tarihinden itibaren 3 yıl geçerlidir. Bu sertifikanın mülkiyeti ArtPlus Eğitim Danışmanlık ve Yedim San. Tic. Ltd. Şti'ne aittir. İstisnalarla ilgili sorular için:

DeviCert

CERTIFICATE
SERTEFİKA

SMART ALÜMİNYUM İNŞAAT MÜHENDİSLİK MÜŞAVİRLİK
SANAYİ VE TİCARET LIMITED ŞİRKETİ

Ovacık Mahallesi,2034. Sokak No:6B Alüminyumcular Sitesi KEÇİÖREN/ANKARA

ISO 45001:2018

Scope / Kapsam

Alüminyum Bar, Çubuk, Tel, Profil, Tüp, Boru ve Bağlantı Parçaları İmalatı, İthalatı ve İhracatı

Manufacturing, Import and Export of Aluminum Bars, Rods, Wires, Profiles, Tubes, Pipes and Fittings

This certificate certifies that the organization mentioned above meets the requirements of the stated standard. Bu sertifika ile yukarıda adı geçen kuruluşun ve standardın gerekliliklerini karşıladığı tasdik olunur.

Certificate Number / Sertifika No: O-250516-140-003

Date of Initial Reg. / İlk Kayıt Tarihi: 16.05.2025

Date of Certificate / Basım Tarihi: 16.05.2025

Date of Expiry / Geçerlilik Tarihi: 15.05.2026

Revision / Revizyon: 00

This certificate is valid until the end of the three-year certification period, provided that the organization complies with the certification body's requirements and successfully passes the annual surveillance audits conducted at least once a year. Bu sertifika kuruluşun sertifikasyon şartlarına uygun ve yılda en az 1 kez yapılacak olan gözetim denetimlerinin başarılı geçmesi halinde 3 yıl süreyle sertifikasyon belgi tarihine kadar geçerlidir.

General Manager
Genel Müdür

DEVICERT INTERNATIONAL INSPECTION, CERTIFICATION AND TRAINING SERVICES DOO
HERCEGOVAČKA 50 PODGORICA info@devicert.com devicert.com



TURK PATENT
TÜRK PATENT VE MARKA KURUMU
MARKA TESCİL BELGESİ

No: 2024 185054 - Ticaret - Hizmet



SMART
CAM BALKON
ALÜMİNYUM

Marka Sahibi
SELMAN YILDIZ

Mal / Hizmet Sınıfları
19, 35

Bu marka, 6769 sayılı Sınai Mülkiyet Kanunu kapsamında, 31.12.2024 tarihinden itibaren 10 yıl süreyle korunmak üzere, 30.07.2025 tarihinde tescil edilmiştir.

Prof. Dr. M. Zeki DURAK
Başkan



SMART
— ALÜMİNYUM —

KALİTE • GÜVEN • ÇÖZÜM

Yaşam alanlarınıza değer katar



DAYANIKLI

Uzun ömürlü
güçlü sistemler



AKILLI SİSTEMLER

Teknoloji ile entegre
kaliteli çözümler



ESTETİK TASARIM

Mimari ile uyumlu
modern çizgiler



YÜKSEK KALİTE

Standartlara uygun
üretim anlayışı

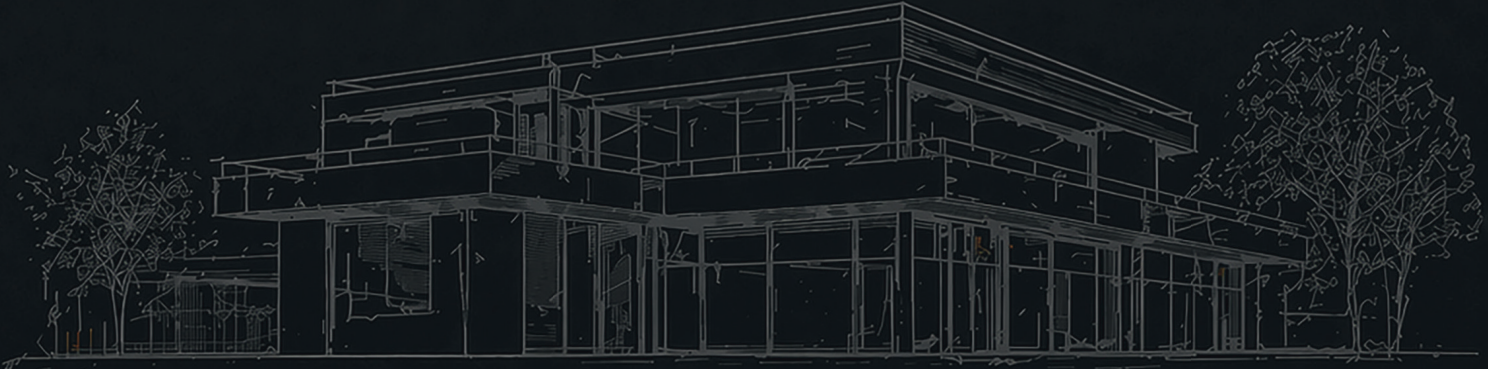

“ GELECEĞE DEĞER,
YAŞAMINIZA KONFOR. ”



✉ info@smartcambalkon.com

🌐 smartcambalkon.com

☎ **0534 292 62 22**

📍 Ovacık Mah. 2034. Sok. No:6B
Alüminyumcular Sitesi KEÇİÖREN/ANKARA

